

12/95

LA-12388-M  
MANUAL

UC-714  
Issued: November 1992

# NUCLEAR CRITICALITY SAFETY: 5-DAY TRAINING COURSE

Offered at  
The Los Alamos National Laboratory

Edited and Compiled by  
John A. Schlessor



MASTER

**Los Alamos**  
NATIONAL LABORATORY

Los Alamos, New Mexico 87545

EP

LA--12388-M

DE93 002308

### ABSTRACT

This compilation of notes is presented as a source reference for the criticality safety course. It represents the contributions of many people, particularly Tom McLaughlin, the course's primary instructor.

# Table of Contents

- I. General**
  - 5-Day Course Objectives
  - Course Critique
  
- II. History**
  - Early History of Criticality Safety
  - Criticality Control in Operations with Fissile Material
  - Criticality Risk in Perspective
  
- III. Fundamentals**
  - Fundamental Concepts and Simple Fissioning Systems
  - Factors Affecting Criticality Safety
  
- IV. Analysis Methods**
  - Critical Dimensions of Systems Containing  $^{235}\text{U}$ ,  $^{239}\text{Pu}$ , and  $^{233}\text{U}$
  - Buckling Conversion Example
  - Storage and Transportation
  
- V. Administrative Practices**
  - Communication Links in Nuclear Criticality Safety
  - American National Standards
  
- VI. Accidents and Incidents**
  - A Review of Criticality Accidents
  - Process Criticality Accident Likelihoods, Consequences, and Emergency Planning
  - Probabilistic Risk Assessment Applications
  
- VII. Glossary**
  - Glossary of Nuclear Criticality Terms
  - Reference List
  
- VIII. Experiments**
  - Experimental Plans

## Revisions

| <u>Date</u> | <u>Description of revision</u> |
|-------------|--------------------------------|
| 11/92       | Original issue                 |

# 5-Day Nuclear Criticality Safety Course

## Objectives

At the completion of this training course, the attendee will:

- be able to define terms commonly used in nuclear criticality safety.
- be able to appreciate the fundamentals of nuclear criticality safety.
- be able to identify factors which affect nuclear criticality safety.
- be able to identify examples of criticality controls as used at Los Alamos.
- be able to identify examples of circumstances present during criticality accidents.
- be able to identify examples of computer codes used by the nuclear criticality safety specialist.
- be able to identify examples of safety consciousness required in nuclear criticality safety.
- have participated in conducting two critical experiments.
- be asked to complete a critique of the nuclear criticality safety training course.

# 5-Day Nuclear Criticality Safety Course Critique

Please Enter: Course Dates \_\_\_\_\_; Instructor \_\_\_\_\_

Please check the appropriate boxes, where 5 = excellent or high and 1 = poor or low.

|  | Excellent |   |   |   | Poor |
|--|-----------|---|---|---|------|
|  | 5         | 4 | 3 | 2 | 1    |
| <b>Course Objectives</b>                 |           |   |   |   |      |
| Were the course objectives well defined? |           |   |   |   |      |
| Were the course objectives achieved?     |           |   |   |   |      |

|   |  |  |  |  |  |
|---|--|--|--|--|--|
| <b>Course Content</b>                     |  |  |  |  |  |
| What was the overall level of difficulty? |  |  |  |  |  |
| Is the course technically appropriate?    |  |  |  |  |  |
| Is the course relevant to your needs?     |  |  |  |  |  |
| Is the course applicable to your work?    |  |  |  |  |  |

|  |  |  |  |  |  |
|--|--|--|--|--|--|
| <b>Presentation</b>                          |  |  |  |  |  |
| Was the course well organized?               |  |  |  |  |  |
| Was the instructor knowledgeable?            |  |  |  |  |  |
| Was the material presented clearly?          |  |  |  |  |  |
| What was the overall student participation?  |  |  |  |  |  |
| Did the instructor respond to student needs? |  |  |  |  |  |
| Was the instructor audible?                  |  |  |  |  |  |

|  |  |  |  |  |  |
|--|--|--|--|--|--|
| <b>Visual aids</b>                     |  |  |  |  |  |
| Were the visual aids useful?           |  |  |  |  |  |
| Did the visual aids clarify the topic? |  |  |  |  |  |
| Were the visual aids appropriate?      |  |  |  |  |  |

|                          |  |  |  |  |  |
|--------------------------|--|--|--|--|--|
| <b>Environment</b>       |  |  |  |  |  |
| Lighting?                |  |  |  |  |  |
| Temperature?             |  |  |  |  |  |
| Ventilation?             |  |  |  |  |  |
| Absence of distractions? |  |  |  |  |  |

Comments: \_\_\_\_\_  
 \_\_\_\_\_  
 \_\_\_\_\_

To: T. P. McLaughlin, HS-6

MS F691

# EARLY HISTORY OF CRITICALITY SAFETY\*

Hugh C. Paxton

The stage for criticality safety was set by amazing wartime developments (Table 1). It was only six years from the discovery of fission to operation of the vast Oak Ridge Gaseous Diffusion Plant, three Hanford plutonium production reactors and the associated fuel processing plant. Consider that in today's atmosphere it takes almost twice that time to bring a power reactor into operation in this country (not France or Japan) and that the planned fuel processing plant for Morris, Illinois, was abandoned as impractical. The Hanford plant worked, as did everything else in the wartime program, including nuclear weapons. Plant designs had to proceed without criticality safety guidance, for critical experiments awaited the availability of enriched uranium and plutonium. Generous design of the fuel processing plant, however, allowed for conservative operation in the absence of criticality information and subsequent adaptation to realistic criticality safety restrictions.

**Table 1. Historic events from the discovery of fission to operations at Oak Ridge and Hanford.**

---

|                |                        |
|----------------|------------------------|
| 1939 (January) | Fission discovered     |
| 1943 (January) | Chicago pile operation |

## HANFORD PLUTONIUM PRODUCTION

|                  |                             |
|------------------|-----------------------------|
| 1943 (June)      | Construction started        |
| 1944 (September) | Reactor operation           |
| 1945 (early)     | Three reactors in operation |
|                  | Processing plant operation  |

## OAK RIDGE ISOTOPE SEPARATION

|               |                           |
|---------------|---------------------------|
| 1943 (August) | Construction started      |
| 1945 (Summer) | Diffusion plant operation |

---

---

\* From the 1985 Nuclear Criticality Safety Short Course sponsored by the University of New Mexico, Albuquerque, N. M., July 1985.



Critical experiments were not long in the coming, and some of the earliest were undertaken at Los Alamos in early 1946 by an Oak Ridge team that included Dixon Callihan. The purpose was to simulate accumulations of enriched uranium that might occur in the diffusion plant as the result of  $UF_6$  condensation or the reaction with moisture in the case of accidental air leakage. One-inch cubes of  $UF_6-CF_2$  (polytetrafluorethylene), with the uranium enriched to 95%  $^{235}U$ , represented the  $UF_6$ . These cubes were mixed in various degrees with polyethylene blocks to introduce hydrogen. Such a core with a partial paraffin reflector is shown in Figure 1. Measurements on sufficient variations of an assembly at an  $H : ^{235}U$  atomic ratio of 10 permitted crude extrapolation to a homogeneous core. Otherwise, the heterogeneity could not be handled reliably by calculations available at the time. Thus, although the experiments provided valuable guidance, they did not provide detailed confirmation of existing calculations.

It may be noted that the development of Monte Carlo computational techniques has changed this situation so that these first Oak Ridge experiments can be used for checking calculations. For example, the heterogeneous assembly at  $H : ^{235}U = 10$  has been recently modeled for KENO, which, with Hansen-Roach cross sections, gives  $k = 0.999$ .

In the meantime, Los Alamos experiments, primarily with fissile metal and hydride, were adding to Oak Ridge and Hanford data to provide criticality safety guidance for the weapons program. Solutions containing  $^{235}U$  and plutonium had to be refined and then reduced to the metal; components had to be cast and machined; scrap had to be reprocessed — all with criticality restrictions. Because of wartime urgency, the required experiments were carried out manually until the second fatal accident in which reflector material around a plutonium ball slipped into place instead of being lowered gradually. This accident caused the death of Louis Slotin, who was an advisor concerning the Oak Ridge experiments. As a result of these accidents, subsequent experiments were controlled remotely — at a distance at Los Alamos, and in shielded cells at Oak Ridge, and later, at Hanford.

Other early experiments with plutonium solutions at Hanford provided needed criticality guidance for the large plant that processed fuel from the plutonium production reactors. A great mass of data was provided before the original — rather makeshift — setup was replaced by the shielded cells in use at this time.

In 1947, the so-called vault tests at Los Alamos provided information to guide the safe storage of massive weapons capsules that were in early production. The entire stockpile of units was built into arrays of various spacings within close-fitting concrete enclosures that separated into parts for loading and were closed remotely. These assemblies represented extremes of what would be encountered in actual vaults at storage sites. Figure 2 is a schematic of a full 27-unit array within a closed vault. Security arrangements at the time, including an army tank, were almost the equivalent of what we see now to protect much less sensitive fissile material.

An attempt to generalize results of the vault tests (see Figure 3) resulted in the so-called "density-analog" scheme, so named because it compared an array with a single unit of reduced density. For a single unit, the critical mass varied inversely as the density to some power, and the apparent log-log relationship of Figure 4 suggested the same sort of variation for an array. Although the original density analog generalization proved to be faulty, it provided conservative guidance for the storage of large numbers of weapons capsules as in the storage array of Figure 5. Incidentally, these massive capsules have disappeared as weapon design has become more subtle.

Joe Thomas has rescued the "density-analog" designation by modifying it to agree with the elegant Oak Ridge experiments with arrays of massive enriched uranium units. Figure 6 shows how poorly the original scheme lines up with the Oak Ridge array data, and Figure 7 indicates the nature of Joe's improvement.

Other presentations of this short course show the way in which the early experimental information has multiplied and been supplemented by powerful computational techniques. They show how the field of criticality safety has grown from the treatment of specific problems to a mature discipline in which standards play an important role.

•

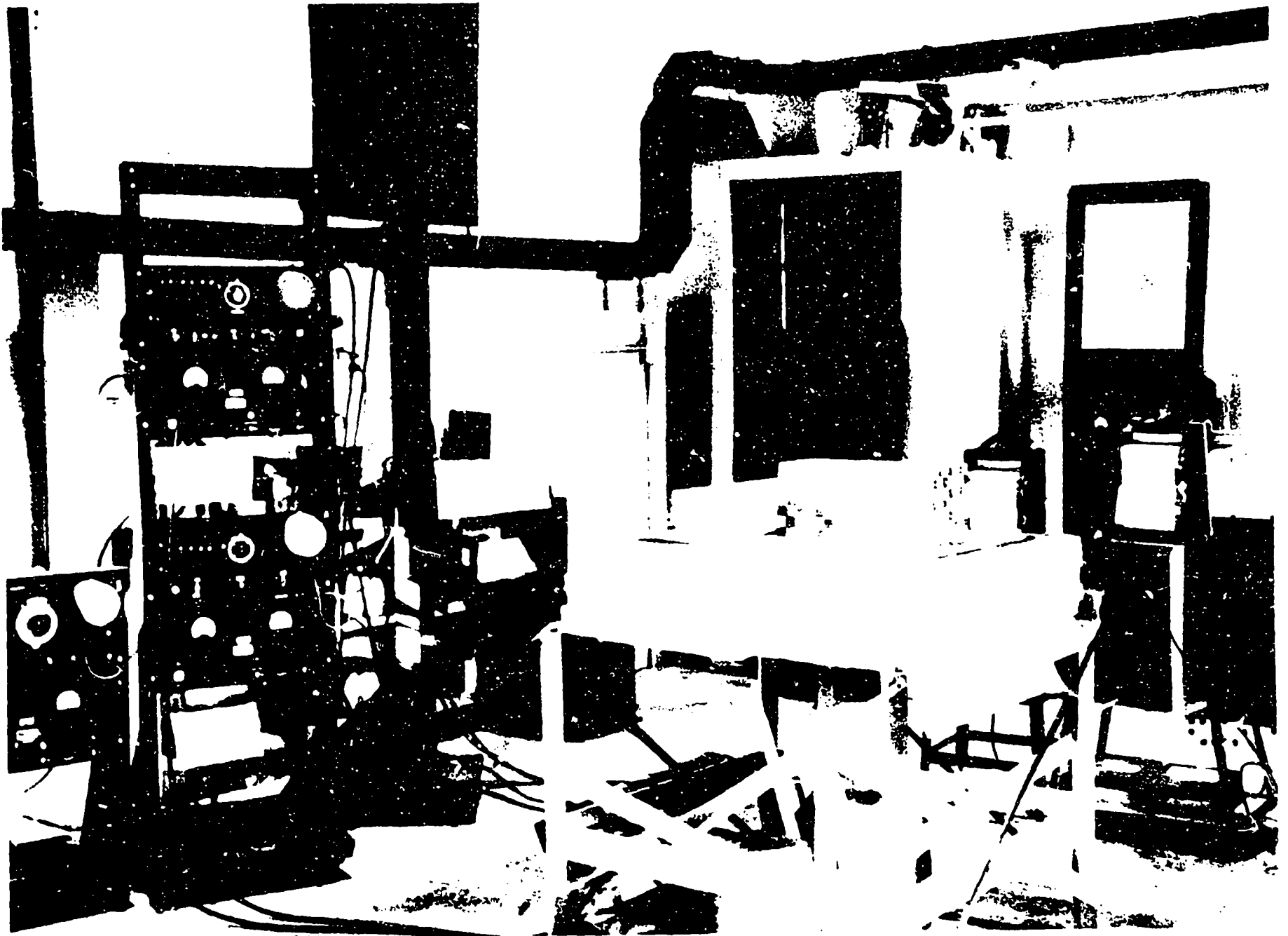

Figure 1. Early critical experiment at Los Alamos.

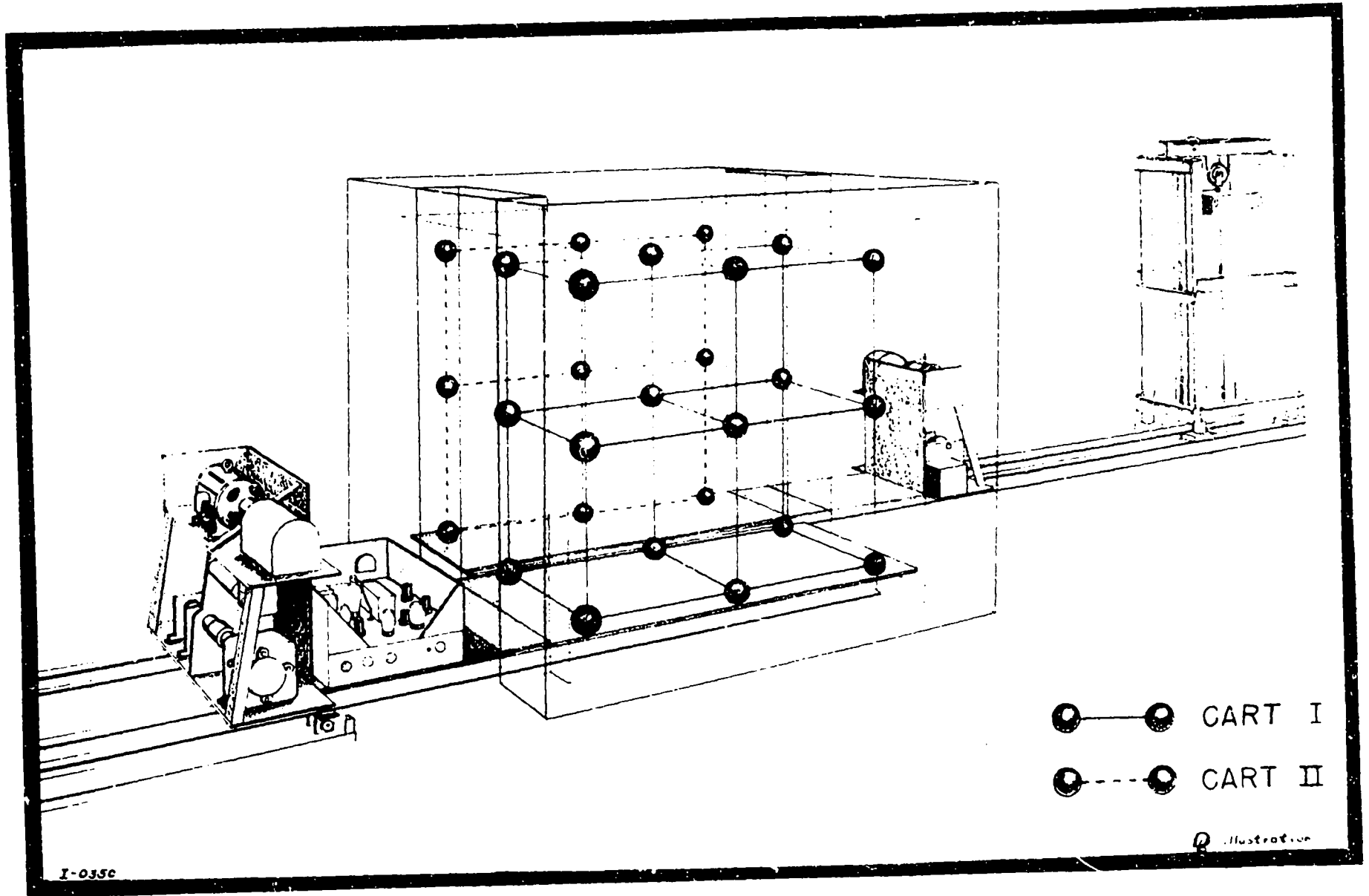

Figure 2. Arrangement of capsules in the Los Alamos vault test.

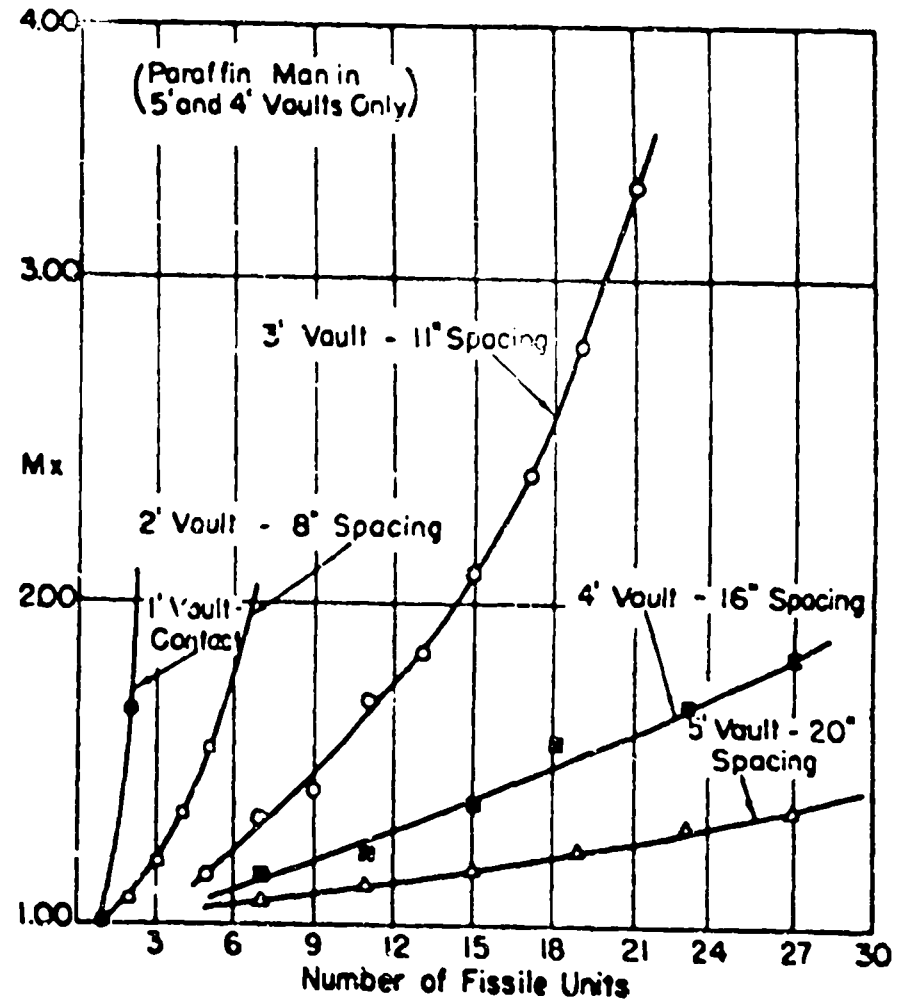
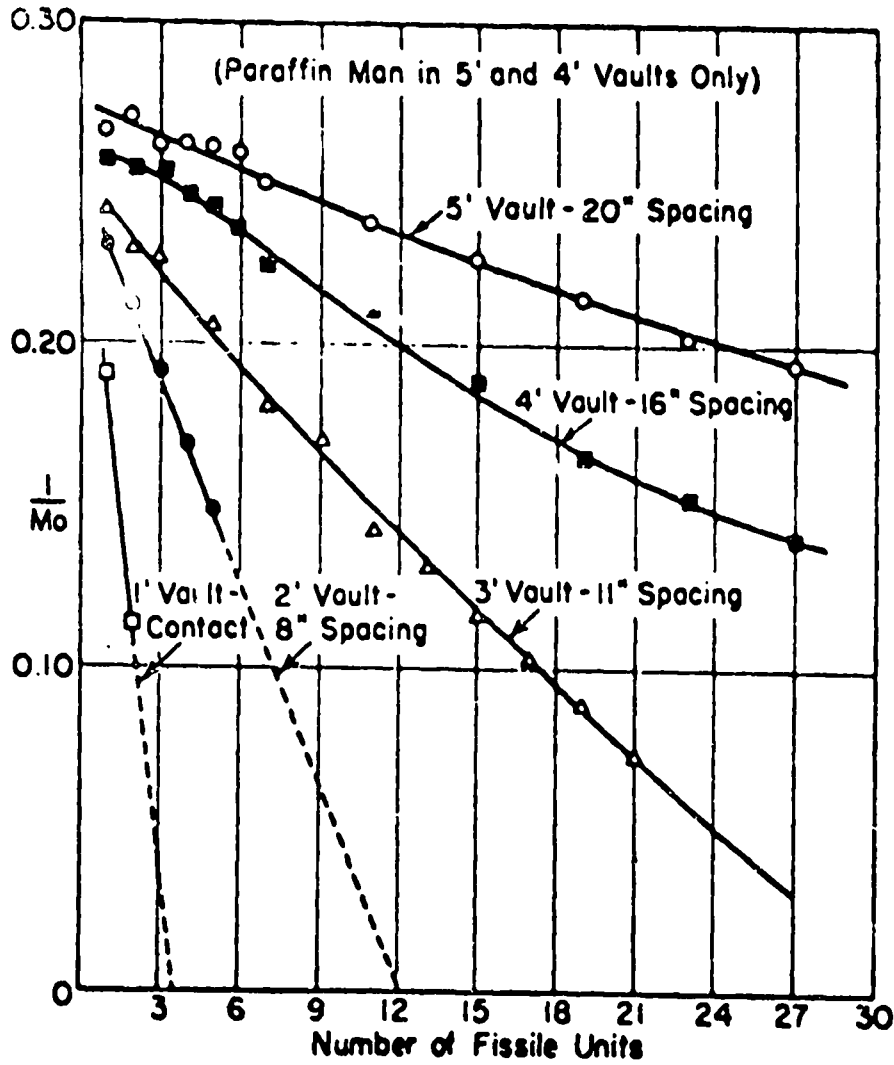

Figure 3. Results of the Los Alamos vault test.

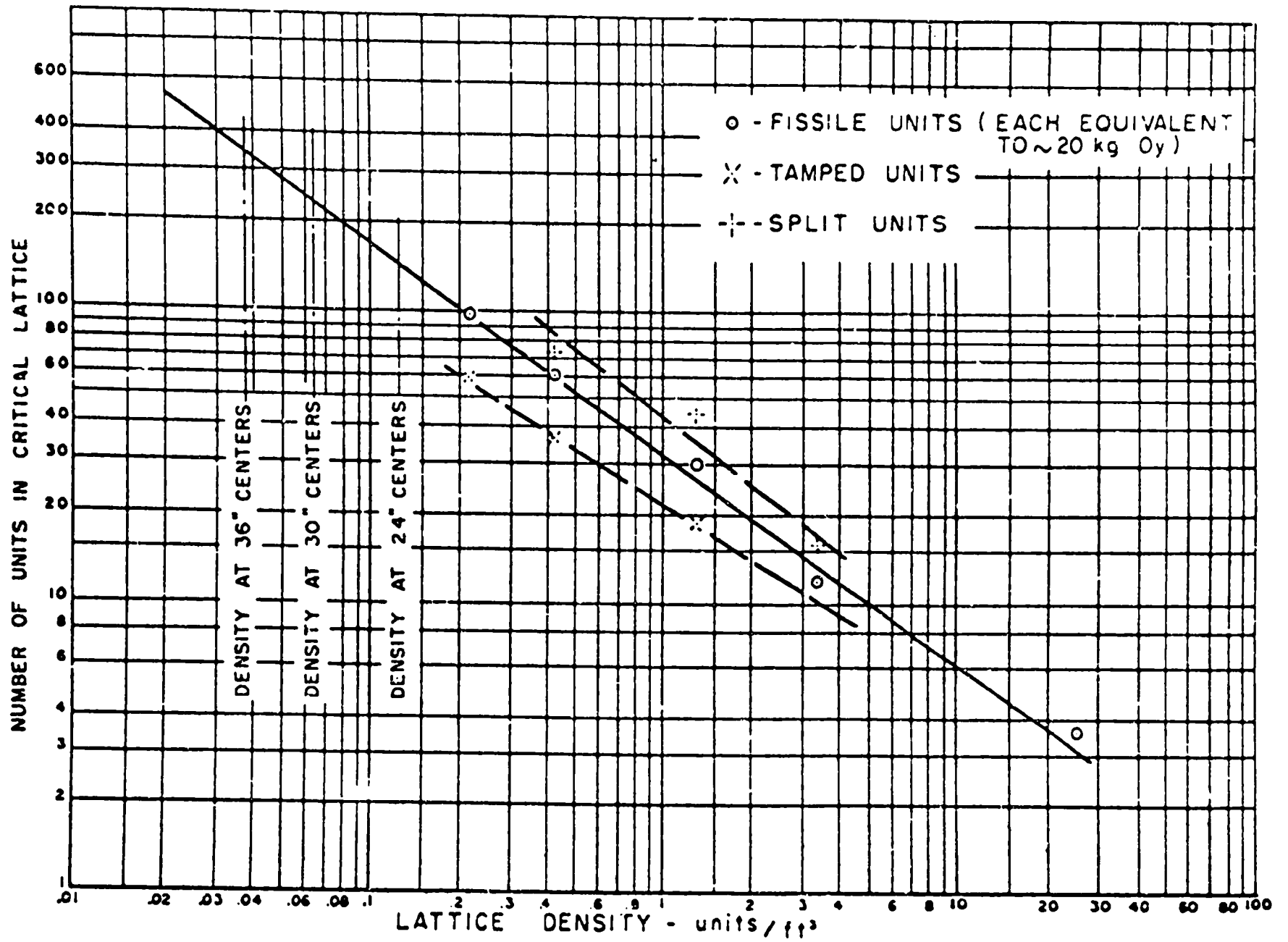

Figure 4. Attempt at generalization of vault test results.

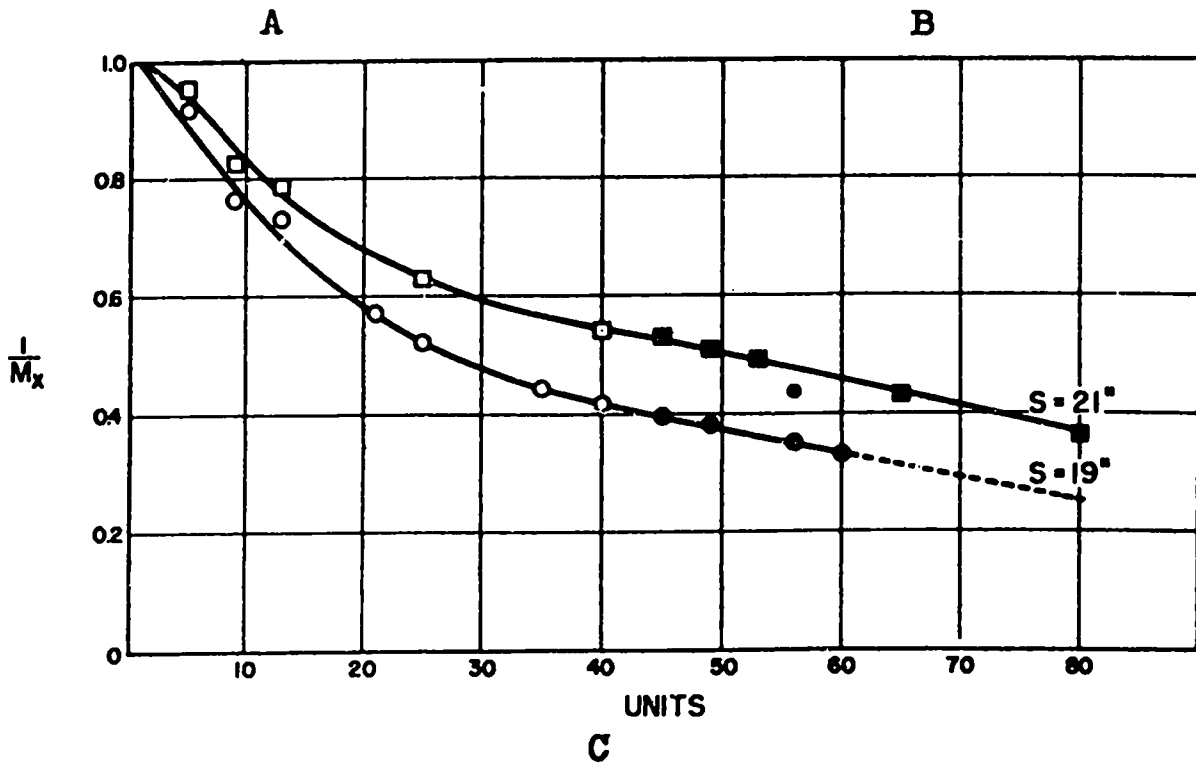
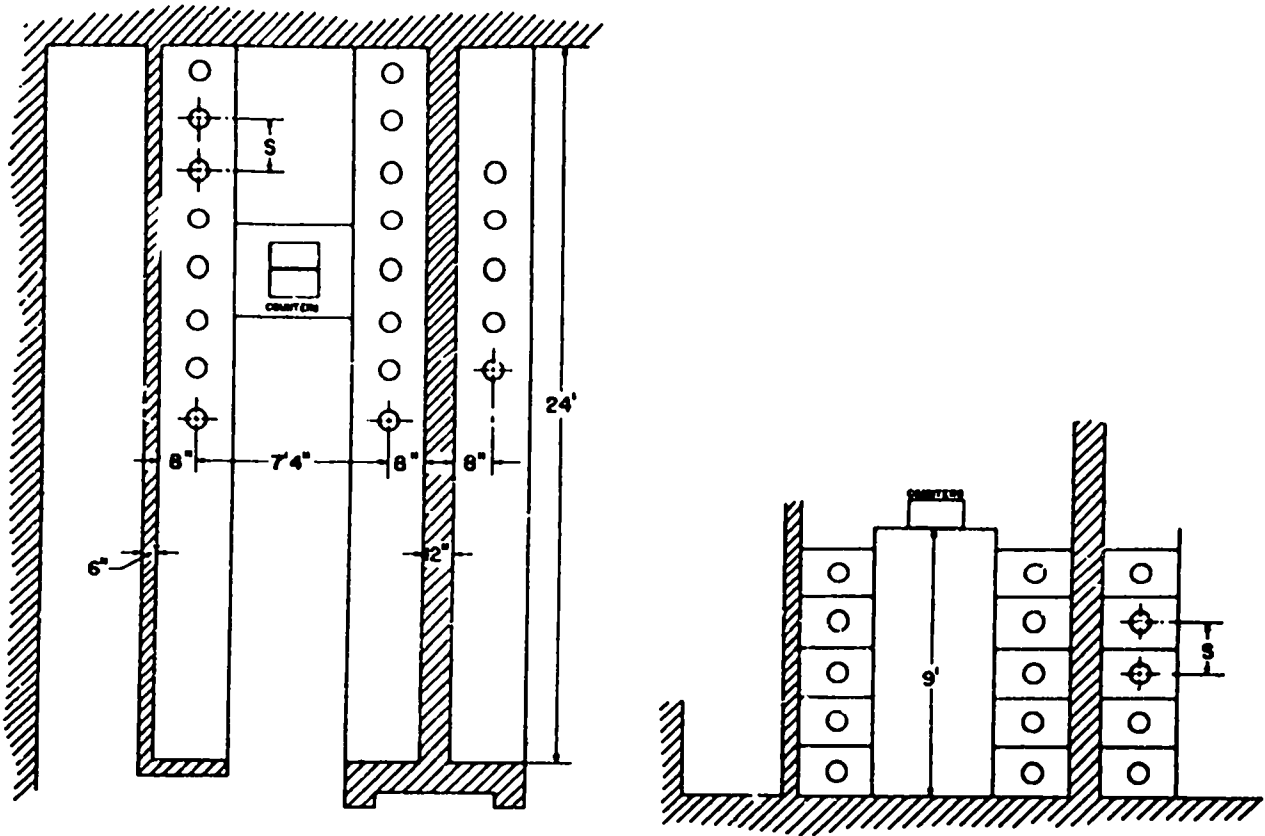

Figure 5. An actual storage array of capsules and results of measurements as spacing was decreased.

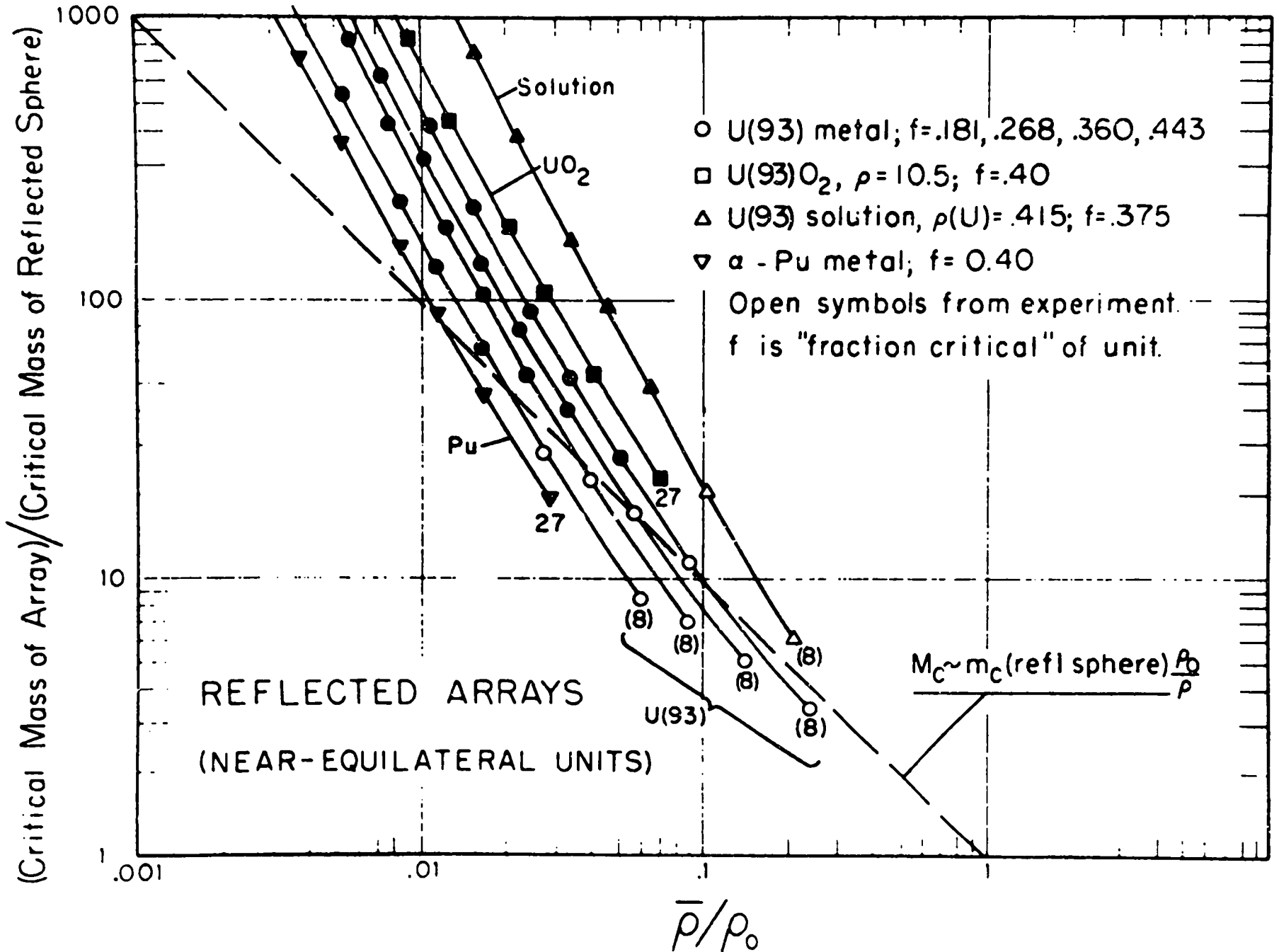

Figure 6. Comparison of the original density-analog scheme with Oak Ridge array results.



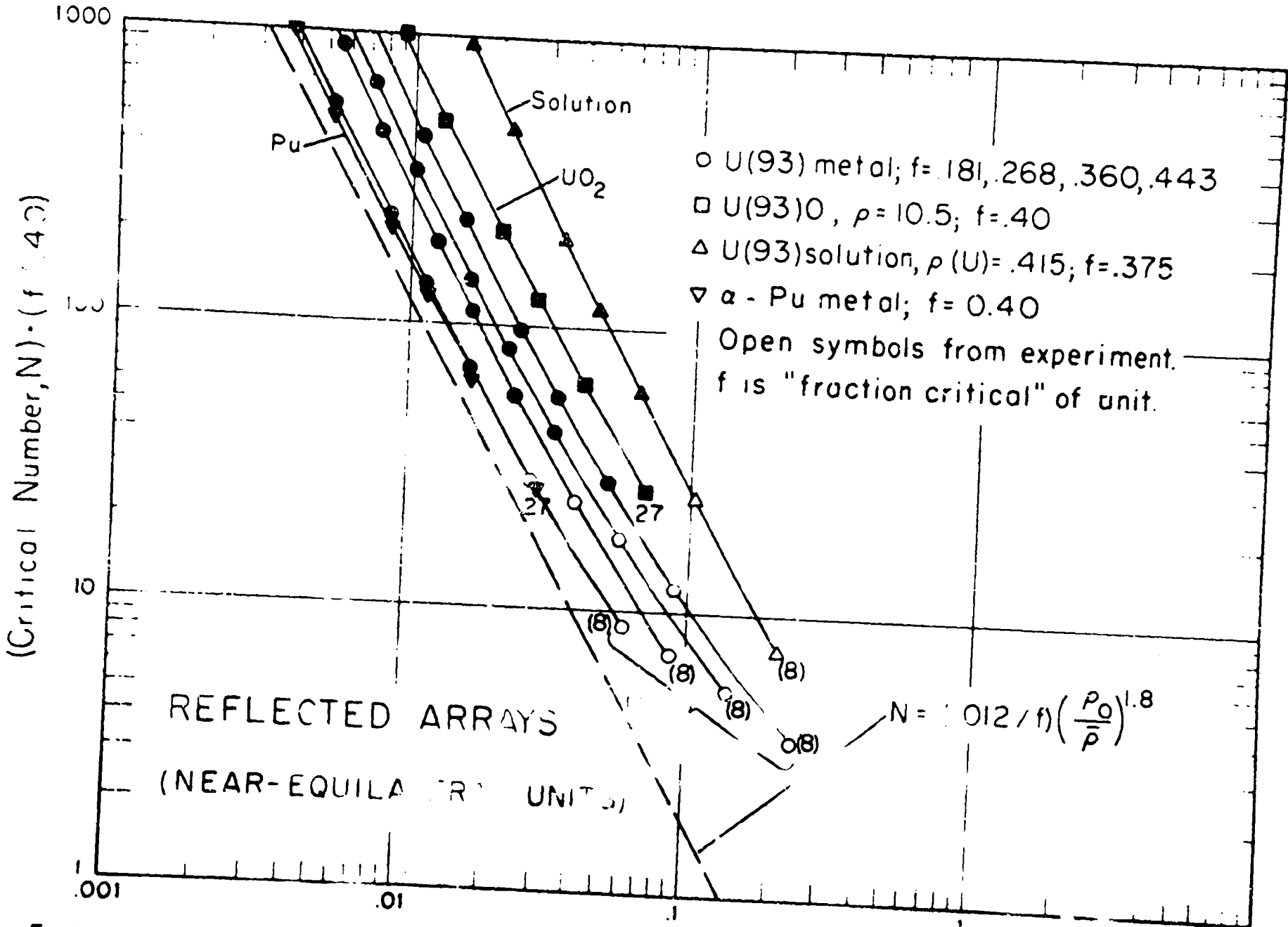

Figure 7. The Thomas' improved density-analog representation compared with Oak Ridge array results.

# CRITICALITY CONTROL IN OPERATIONS WITH FISSILE MATERIAL\*\*

Hugh C. Paxton

## DEFINITION OF NUCLEAR CRITICALITY SAFETY

Nuclear criticality safety is usually defined as the art of avoiding a nuclear excursion, and, indeed, this is usually the practical viewpoint. However, we should recognize the situation demonstrated by the Idaho accident of January 1961, in which the consequences of an excursion were trivial. A process may be designed to include shielding, confinement, and other conditions like those at Idaho so that the probability of an excursion may be allowed to increase. In at least two instances, this alternative has proved less expensive than an unshielded process with the appropriate added restrictions.

Perhaps, then, nuclear criticality safety may be defined more precisely as protection against the consequences of a nuclear excursion. Although this extended definition points out a flaw in our use of "criticality control" as a synonym for "nuclear criticality safety," we shall continue to treat these two terms, and the term "nuclear safety" as equivalent.

## PRACTICAL NUCLEAR SAFETY FUNDAMENTALS

Our purpose in this section is to lay the groundwork for a practical philosophy that will be developed throughout the rest of this report. This philosophy is not only specific to criticality safety but is based upon safety principles that were developed and tested before fissile material appeared on the scene. Points of view that we have attempted to introduce for this reason may be stated more specifically as follows:

1. Safety is an acceptable balance of risk against benefit; it is meaningless as a concept isolated from other goals. It follows that safety should be considered one of the goals of design and operation instead of something superimposed.

Although experience has shown that criticality hazards are no more serious than other industrial hazards, controls for balancing criticality risk against benefit are somewhat more stringent than is usual in nonnuclear industry. It is reasonable that there be some allowance for the uneasiness naturally associated with this new type of hazard. But the extreme concept of risk elimination (as implied by any claim that certain controls "assure" safety or "ensure" safety) is dangerously misleading. Dismissing risk as nonexistent can detract from the continuing job of maintaining an acceptably low risk level.

2. Accident prevention depends upon responsibility for safety implementation (and commensurate authority) at the supervisory level closest to the operation, under the general direction and policies set by higher management. Attempts to control detail at a remote level are misguided.

---

\*\* From Los Alamos Scientific Laboratory report LA-3366 (Rev.), November 1972.

Because of the requirement for governmental regulation, great care is required to preserve this precept in criticality safety. Remotely administered detail discourages the on-the-job alertness required for effective control, because it encourages the attitude, "Someone else is taking care of us."

3. Safety regulation should be based upon professionally generated standards and should preserve alternative routes to safety objectives. The arbitrary selection of a single route (as by rule) may eliminate the best economic balance or the most convenient scheme.

Inflexible rules hamstring the designer in a traditional search for the most satisfactory way to fulfill many objectives, and they increase the chance of an awkward operation that invites improvisation. Flexibility frees the designer to apply to integrated process design the considerable experience that has accumulated in the nuclear industry.

4. Other things being equal, simple, convenient safety provisions are more effective than complex or awkward arrangements. Similarly, "free" (no cost) contributions to safety should be nurtured.

As an example of this principle, criticality safety is enhanced by arrangements of material and equipment that tend to make proper operations convenient and maloperation inconvenient.

# **SAFETY IN GENERAL: CRITICALITY RISK IN PERSPECTIVE\*\*\***

Roy Reider

My remarks will be divided into two parts: fundamentals of safety and fundamentals of accident prevention; then we will relate this second part to criticality. Let me delineate the fundamentals of safety:

1. Management leadership in the declaration of policy and assumption of responsibility for control of accidents.
2. Assignment of responsibility to operating officials, safety and health personnel, supervisors, and technical committees.
3. Establishment of requirements for procedures, including review of procedures.
4. Maintenance of safe working conditions, including inspections by specialists (of cranes, elevators, high-pressure equipment, fire-protection devices, etc.), committee inspections, proper purchasing and acquisition, supervisory interest, and other elements.
5. Safety training for supervisors and employees, which could include first aid, emergencies, review of accidents, technical information, protective clothing, safety fundamentals, and a variety of specific subjects.
6. Medical and first aid: preplacement and periodic examinations, treatment of injuries, and health counseling.
7. A system for reporting and recording accidents, including near misses or potential mishaps, which can alert concerned personnel to needed protective measures or procedural changes.

Let us develop these elements of safety on a point-by-point basis.

The most important fundamental in the prevention of accidents is the assignment and the acceptance of responsibility, wherein people at any level of supervision or in staff assignments say readily, "Not only has this been assigned to me as an individual, but also I avow that, if anything goes wrong in the operation with which I have been associated or assigned, come see me." This acceptance of responsibility seems universally to be rapidly fading away from the functions of modern administration, and this is unfortunate.

I emphasize that the most important fundamental is the assignment and acceptance of responsibility. This responsibility must be accompanied by the authority and resources that are commensurate with the degree of responsibility expected.

Fifteen years ago at the laboratory where I worked, there was a series of devastating explosions. These mishaps cost the lives of six employees and left 28 fatherless children. The most common deficiency leading up to these accidents was the lack of appropriate operating procedures.

When I spoke to people, some of my own people, reminding them how remiss we had been in the steps available to avoid these catastrophes, they said, "Oh, you

---

\*\*\* From the 1973 Nuclear Criticality Safety Course sponsored by the University of New Mexico, Taos, N. M., July 1973.

asked them to have procedures; twice you asked them to have procedures." I could have done this 40 times and still have been remiss because I had not yet exhausted all the resources available to me to prevent these mishaps. If you stand somewhere in the chain of responsibility for the performance of people and you have not exhausted all the resources, you share responsibility for what goes wrong. The more you obsess yourself with this idea, the less are the chances, I believe, that accidents will occur. Supervisors closest to the operations being performed, those in the first line of supervision, those closest to the employees carrying out the procedures, must have the assigned responsibilities. Accepting this, they can proceed to carry out the elements of a program necessary to control accidents. The management chain above the supervisors shares this safety responsibility, perhaps in a more limited way, but clearly their support is required in the many elements of the safety program: reiteration of policy, provision of resources, and the willingness to exert a heavy hand.

We start off here with management leadership and the importance of assigned responsibility. It is very simple when management says, "This is our establishment. We propose to proceed in a certain way. We want a certain level of safety." These cannot be left to words, however. In King Henry, Shakespeare, speaking of the king walking among the troops on the night before battle, used a phrase "a little bit of Henry in the night." Management leadership as a policy which is printed on a piece of paper to give out to new employees or which is recited by the personnel people to a new employee during orientation is great. But this consists only of words. It cannot be left at words; it requires not only management policy, but also leadership and participation. If safety is left entirely to the safety people to accomplish, it is going to be poorly, inadequately, and sometimes ineptly done. When management participates in as well as expresses a policy, doing more than merely making statements, an important step is taken toward safety.

Assignment and acceptance of responsibility are things I hope I have made perfectly clear as far as my own feelings are concerned.

## **ESTABLISHMENT OF PROCEDURES**

The more hazardous an operation, the more necessary it is that there be a procedure thought out ahead of time and checked by competent higher authority — not by remote authority, but by close and competent authority. The more hazardous the operation, the greater is the need for the procedure that is expressed by the people who do the work, reviewed by people who are competent in the work and approved by higher authority. Let us substitute now for the word "hazardous" the words "expensive" of the history of nuclear energy and the history of nuclear safety, by the stretch of the imagination can we say that criticality is fairly characterized as a high risk. We can substitute for the word "hazardous" the word "sensitive," the words "operation that can create tremendous public reaction," or the word "expensive." So, wherever we have an operation that can be characterized by these extremes — the extremes of hazardous, expensive, or causing severe public reaction — very real reason exists for procedures that are thought out, reviewed, and approved. Although these procedures have been done in a thoughtful and considerate fashion, they were not given to us as though from Mt. Sinai, engraved in stone. They were procedures created by human beings. Therefore, they require a follow-up on a periodic or nonperiodic basis so long as the procedures are viable. There are many means for us to find our way to the proper path. There is not just one way. I feel no great concern about consistency

or conformity. Procedures should be looked at, reviewed, tested, checked, etc. We will relate the establishment of procedures to things that we will discuss later.

I have mentioned safe working conditions, and this, of course, is no simple subject. It means that we wish to build a safe environment, to maintain a safe establishment, and to continue to review the establishment by a variety of means to see that it stays at a safe level.

I hope no one will accuse me of dismissing physical inspections, but the greatest need in accident prevention and in safety training is the management of the behavior of the people. I am not talking about psychological or inspirational matters or slogans. But the most fruitful avenue in accident prevention is indeed the management of personal conduct, which is accomplished through the route of procedures and, here again, through the route of safety training. The larger the establishment, the more numerous are the bureaus it has. There may be all kinds of safety and health people, criticality safety people, public relations offices, etc. Often there are special personnel to do the safety training. However, the more of this training in procedures and in the fundamentals of criticality, that is done by people like the actual supervisor, the better it will be done. This closeness to the problem provides not only technical accuracy and technical relevancy, but also provides us with a little of this "King Henry in the night," where the immediate supervision is expressing its management leadership in safety training for these important procedures.

## ACCIDENT AND INCIDENT REPORTING

The accident experience in nuclear criticality is so limited that the few misadventures which have occurred do not permit any statistical analysis. Statistics in accident prevention are used mostly, anyway, to make favorable or unfavorable comparisons that seem to serve the personal purposes of the user.

Thoughtful and detailed analyses of descriptive reviews of accidents are perhaps more useful in establishing accident prevention techniques and standards.

There is much to be learned in the analysis of misadventures, sometimes termed "near incidents," which did not result in any loss or injury. These mishaps that are nonaccidents can be powerful tools in accident prevention, as warning agents and as signals alerting us that perhaps we have deficiencies in our processes, procedures, equipment, maintenance, training, or supervision.

I am not unmindful of the problems and exacerbated reactions that seem to follow the reporting of even inconsequential misadventures. I recognize that often these reactions are self-serving rather than safety-serving. However, I have to believe and I have to teach that accident information and near-incident information are powerful forces for accident prevention.

The second greatest tragedy of an accident is that it does not serve sufficiently to prevent similar future mishaps. Near-incident information can often be equally important.

As a safety engineer, I realize that I cannot be just one of those who reaches his limited level of flowering by being one of the kind who recites to a second party the misfortunes of a third party and considers that recitation a professional accomplishment.

I wish I could devise a clever scheme that would commend and reward those who willingly make available to their colleagues information on their own near-mishaps. I know it is my responsibility to shield them from the irresponsible reactions of inept authorities, who overact to this kind of information. I realize I have not always been successful in providing this shield. However, I insist that

such near-miss information is such an important accident prevention tool that it must not be hidden and lost.

## **THE SUPERVISOR AND ORIENTATION FOR THE NEW EMPLOYEE**

Safety training for a new employee is often started within an organization in a "new employee orientation program." This program is usually carried out by the personnel department, and often the safety and health departments participate. These are good programs, and they are helpful to the supervisor by relieving him of many administrative details. I play a role in these programs myself. I do not turn this responsibility over to the personnel department, because I feel I do it better and that I should do it. Still, what I do in safety orientation for the new employee is not nearly so important as what the supervisor can do to impress the new employee. The supervisor is closer to the employee and to the operation, and can make the strongest impressions on the new employee.

## **THE SUPERVISOR AND THE INDUSTRIAL PHYSICIAN**

In modern industry, there are medical procedures of pre-employment, pre-placement, and periodic physical examinations. In some sensitive areas, e.g., in the handling of fissile materials where nuclear safety might be a consideration, there is often a requirement that the individual be certified for a critical-duty assignment. This certification is usually part of the periodic examination by the physician, and this means that the physician sees the employee perhaps once a year.

However, the supervisor sees the employee every day and is in the best position to judge whether any significant change is taking, or has taken, place. I am not suggesting that the supervisor needs to be trained in special medical or psychological techniques or that he make definitive judgment in these areas. He, nevertheless, can observe changes on a day-to-day basis that would warrant referral of the employee to the appropriate authority.

The point I am making again and again in various areas is that the supervisor should not leave to the physician, to the training people, or to the safety people, the responsibility for the conduct and training of his employee.

All these things add up to developing in an employee a sense of personal responsibility for safety.

## **TECHNICAL RESOURCE COMMITTEES**

A supervisor must direct and counsel the action of others. The supervisor is responsible for the working conduct of his employees and presumably is authorized to control this conduct. In turn, the supervisor is responsible to higher authority, whose job is to support the supervisor with the resources, including technical ones, needed for proper performance.

In criticality safety, there are a variety of technical resources, such as manuals and codes, operating limits, and nuclear criticality safety specialists. A specialist can advise, help, review, and also monitor criticality activities. Whether or not there is a criticality specialist, there could be a technical committee to help. There are really two types of committees, both useful and therefore both important.

One kind of committee is an instrument of the supervisor; this is a broad term, but I am trying to describe a committee that is formed by and for the supervisor to advise him. This is a local committee, close to the operation, who will review

the operations for the supervisor and advise him. An outside technical person might be a member of such a committee, but most of the committee would be local.

The second kind of technical committee would be an instrument of management, a technical resource and review committee reporting to authority higher than the supervisor. Such committees can be usefully devised for operations like criticality, electrical safety, explosives, cryogenics, and reactors. They are used in those areas generally termed potentially hazardous or sensitive.

The management committee operates not only to help the supervisor, but also to monitor his activities. The committee acts for the management, which has neither the opportunity nor the competence to examine in depth the technical aspects of the operations.

The two kinds of committees, local and management, do different things and have different functions, and both can be very useful.

My summary words on committees are that they should be made up of the best people you can find who are competent in the subject with which they are expected to deal. The fact that these good people might also be busy people is not necessarily a disadvantage. If I can possibly do it, I try to pick as committee members those individuals who will not fall in love with their committee work; they should otherwise be too busy. I may be misquoted here, but I want really good people on the committee. These, by definition, are busy people; when they devote time to the subject of being a technical resource, they are going to be direct, straightforward, and useful. They are not going to be concerned with inconsequential details, because they do not have the time for it and they do not have the inclination for it. I believe strongly in technical resource advisory committees, but these committees must not dilute the responsibility of the supervisor. They provide him with technical counsel. They monitor his operation and report to higher management. They are very useful. However, I prefer busy people so that their committee assignment does not become their most important occupation; otherwise mischief will result.

## **SAFETY MOTIVATION**

The motivation of an individual for safety can be either directed or self-induced. The first is exclusively the responsibility of higher authority, and the latter perhaps is equally divided between management and the individual.

Directed motivation for accident prevention is brought about by updated documented procedures in the use of which employees are properly trained, continuously supervised, and periodically checked. This directed motivation is enhanced by various arranged techniques for accident prevention, which include selected supervisors whose responsibility is clearly defined and accompanied by commensurate authority, employees assigned for their ability and judgment, and a safe working environment.

Independent of directed motivation for safety is the personal motivation for preventing accidents, which is the matter of self-preservation. This self-motivation depends primarily on understanding what kind of accidents can occur and what the consequences are.

In the technologies of potentially high hazard, considerable efforts are commonly exerted to acquaint employees with the consequences of misadventure. We, however, cannot equate the importance of self-induced safety motivation with directed safety motivation. A supervisor has no more right to rely on the feeling of an employee for self-preservation than he has to rely on the enveloping cloak



of safety allegedly provided by detailed rules from remote authority. At least 90% of safety motivation must come from above.

## **CRITICALITY SAFETY DATA**

The amount of criticality safety data is certainly growing steadily, and there may still be need for more information. However, it was realized many years ago that there was sufficient criticality safety information available to permit safe management of fissile materials. There is good historical evidence that sufficient theoretical knowledge about critical processes was on a sound basis before sufficient materials to cause a criticality accident even existed.

The foregoing points to human behavior as the main problem of nuclear safety. Certainly there is no evidence that the state-of-the-art lacked criticality information in any of the few mishaps that have occurred.

Therefore, emphasis must be kept on the administrative aspects of nuclear safety and on the continuous application of sound and basic safety fundamentals for the management of nuclear facilities, as one would do for any hazardous, expensive, or sensitive operation.

## **SPECIAL PROBLEMS**

Every hazardous industry or industry with any unique risk has special safety rules or requirements that are not usually found elsewhere.

For example, in restaurants or any food-preparation industry, employees are trained and cautioned to wash their hands after going to the bathroom. When I first worked in the chemical explosive industry, particularly in acid manufacturing, I was cautioned that I should wash my hands before going to the bathroom.

Criticality safety requires a knowledge of the fundamentals of its particular problems and the use of our imagination in the avoidance of these same problems.

An example occurred in an enriched-uranium processing plant a few years ago. The plant processed mostly solutions that were moved around in piping and reaction vessels that were of ever-safe geometries. The supervisor entered the processing area one day and noticed that an employee had placed a pail under a leaking joint to catch the solution that was leaking onto the floor. Of course, this was collecting the solution in a different geometry. The supervisor immediately established and posted a safety rule "DANGER — Leaks MUST be allowed to Drip on the Floor." Here is an example of a "near-accident" providing important information to an imaginative supervisor to the safety of the operation.

## **EARLY ACCIDENT HISTORY**

It is the historic nature of new technologies to become safer with acceptance or, conversely, to gain acceptance as these technologies become safer. Since experimental science is an adventure form, it has been all too common, particularly in the comforting wisdom of retrospection, for unnecessary risks to be taken to enjoy direct observation. We do not have to go back to the valiant experimenters of the 19th century, i.e., Gay-Lussac and others, the natural philosophers who insisted on touching, smelling, tasting, and self-experimentation. As recently as the 1960's, the brilliant investigators of noble gas compounds received severe injuries in their work with unstable xenon salts. If we go back to the early days of research with significant quantities of fissile materials, we can find direct-observation accidents.

In one case, a critical assembly was being created by hand stacking 4.4-kilogram tungsten carbide bricks around a plutonium core. The core was a 6.2-kg sphere. The experimenter, working alone, was moving the final brick over the assembly. He noticed from the nearby neutron counters that the assembling of this brick would make the assembly supercritical. As he withdrew his hand, the brick slipped and fell onto the center of the assembly. This additional reflection made the system super-prompt critical; the resulting power excursion had fatal consequences to the individual.

In a second incident, a demonstration was held to show several people the techniques involved in creating a metal critical assembly. The system consisted of the same core that was described earlier but was reflected in this case by beryllium. The top and final beryllium shell was being lowered slowly into place; one edge was touching the lower beryllium hemisphere while the edge 180° away was resting on the tip of a screwdriver. The person conducting the demonstration was holding the shell with his left hand with the thumb placed in an opening at the polar point while slowly working the screwdriver out with his right hand. At this time, the screwdriver slipped from under the shell and it fell completely onto the lower hemisphere. The resulting excursion gave a lethal radiation dose to the demonstrator.

These incidents should be only of historic interest now since the techniques used then would not be considered today. To use these early accidents as examples of the need for more restrictive measures is to deny the evolution of science. As recently as the 1950s, I viewed a draft of a proposed set of specifications for motor vehicles carrying hazardous cargo. Someone had specified that the "lighting system for such vehicles shall be electric." After puzzling over this for a short time, I realized that someone had learned from regulations written shortly after 1920 which forbade the practice of motorized vehicles using acetylene lamps carrying hazardous cargo.

## CONCLUSIONS

My closing remarks are directed to those of you with the responsibility for the accomplishments of others — for their work, their programs, their successes, and their accidents. Do you really know what your people are doing and how they are doing it? Do your people know the nature and consequences of misadventure? Have you provided sufficient guidelines for a safe level of performance — instructions, safe operating procedures, and safety manuals or guides? In the words of Laennec, great physician and inventor of the stethoscope, "Do not fear to repeat what has already been said. Men need the truth dinned into their ears many times and from all sides. The first rumor makes them pick up their ears, the second registers, and the third enters."

# FUNDAMENTAL CONCEPTS AND SIMPLE FISSIONING SYSTEMS

Thomas P. McLaughlin

## I. INTRODUCTION

To accommodate the diverse levels of both experimental and theoretical knowledge of nuclear matters of those participating in this course, basic concepts and nomenclature will be introduced, but mathematical developments will, in general, not be presented. References are given for those who may wish to explore the mathematics and physics that underlie the materials covered herein. However, this course has been and will be of interest to people of various backgrounds, and therefore departures from and/or elaborations of this textual material will be made as the questions raised by the participants demand.

Wherever appropriate, the fundamental processes and concepts will be clarified and amplified through examples. Additionally, the tie-in between these somewhat abstract concepts and the real world of criticality safety will be emphasized and reinforced, particularly by the experimental sessions, so that they can later prove useful in guiding your thoughts and decisions concerning the criticality aspects of a particular design, modifications to an existing design, a particular operation, changes in a particular operation, proposed new operating procedures, and so forth. Two important goals of this course are to convey sufficient awareness of factors that affect criticality, and the consequences of accidental nuclear excursions so that realistic, meaningful balances between risk and benefit can be achieved. It is dangerously misleading to imply or believe that risks can be entirely eliminated in any endeavor. What we should strive for is knowledge and perspective which can be applied to maintain risk at an acceptably low level.

## II. CRITICALITY SAFETY VERSUS RADIATION SAFETY

The distinction between these two areas of safety concern should be made clear from the outset. There are thousands of radioactive species in the world, most of which have been manmade during the last few decades, but a few are naturally present in our environment, stemming from the origin of our planet. All radioactive materials possess some potential for being hazardous to your health, and thus appropriate care should be exercised when working with them. On the other hand, criticality safety concerns itself with only a few of these radioactive species — for most practical purposes only with plutonium and uranium.

For example, tritium (symbol  $^3\text{H}$ ) is radioactive and potentially hazardous if it somehow gets into the body. Tritium cannot, however, undergo the fission process (as can uranium and plutonium), and thus the radiation emitted from a fixed quantity of tritium can never increase but can only decrease with time. In contrast, the rate at which radiation is released from uranium or plutonium (due to the fission process) can be increased or decreased by varying its condition or environment, that is, by changes in the geometry of the specimen, addition or removal of surrounding materials (hands, water, etc.), and concentrating or diluting, as with solutions.

Since penetrating radiation (neutrons and gamma rays) is emitted with each fission event, the radiation exposure one is subjected to will rise and fall with the fission rate. Under normal operations involving the handling and processing of plutonium and uranium, the multiplication factor of a system (to be defined later) is kept well below unity (typically in the range 0.1 to 0.8). If during an accident situation the multiplication factor should exceed unity, then the fission rate will rise extremely rapidly with little or no time for an operator to react before inherent, natural mechanisms will reduce the fission rate. If this were to occur, then the radiation exposure could be substantial or lethal even though the duration of exposure will likely be much less than one second and no or minimal mechanical damage will result.

Criticality safety, then, is concerned with planning and conducting operations with uranium and/or plutonium in such a manner that the multiplication factor remains well below unity at all times, i.e., that a nuclear excursion will not occur under both normal and credible abnormal conditions and may reasonably be designed against.

It should be stressed that criticality safety, like other safety areas (vehicular, electrical, falls, fire, etc.), should be taken seriously, but only in proportion to the potential consequences, and further only when weighed against the other areas of safety. For example, if one were to calculate (or even hypothesize) that during an extreme earthquake the uranium/plutonium associated with a certain operation or system could rearrange itself so that the state of criticality of the rearranged material could exceed unity, then one might argue that this situation should be designed against. However, it would not generally be cost effective to spend time and money designing against the criticality if the postulated earthquake is of sufficient severity to destroy the building. The reason for this is twofold: the collapsing building will likely kill any occupants, and the consequences of accidental criticalities are not mechanically damaging and are localized to within a few meters of the event. Thus, personnel even in an adjoining room have never received lethal radiation exposures from a criticality accident.

### III. NOMENCLATURE AND BASIC PROCESSES

We are concerned with the behavior of neutrons in material. A neutron is a chargeless particle of approximately the same mass and size as a proton, or if you will, the same as the nucleus of a hydrogen atom; namely,

$$M_n = 1.7 \times 10^{-27} \text{ kg}$$

and a diameter of

$$D_n = 2.4 \times 10^{-15} \text{ m.}$$

To put these small quantities in perspective it is useful to consider the relative sizes and masses of neutrons and nuclei of atoms. On a relative scale, the neutron and proton (hydrogen nucleus) have a mass of 1, and all other nuclides have relative masses equal to their mass number. For example,  $^{239}\text{Pu}$  has a mass equal to 239 times the neutron mass, and  $^{12}\text{C}$  has a mass equal to 12 times the neutron mass.

Now consider sizes and distances. For our purposes, we may treat neutrons and atomic nuclei as spheres whose diameters,  $D$ , vary according to  $D_A = D_n A^{1/3}$ , where  $A$  is the atomic number. Thus, aluminum, which is 27 times as massive

as a neutron ( $A = 27$ ), has a nucleus whose diameter is only 3 times as great as that of a neutron. The "heavy" elements such as uranium and plutonium have nuclei about 6 times as large as the neutron. Finally, consider distances between atomic nuclei. These are typically  $1-5 \times 10^{-10}$  m. Thus the distance between nuclei is about ten thousand times as large as the size of the nucleus itself! For example, if a neutron were the size of a pea, then the distance between the nuclei of adjacent atoms would be the length of a football field.

Consider a neutron impinging on a slab of aluminum as shown in Figure 1. The neutron may or may not interact in the slab. If no interaction occurs then the neutron is said to have *leaked* from the slab, or the process is referred to as *leakage*. If an interaction does occur, then it may be a *scatter* process or an *absorption* process.

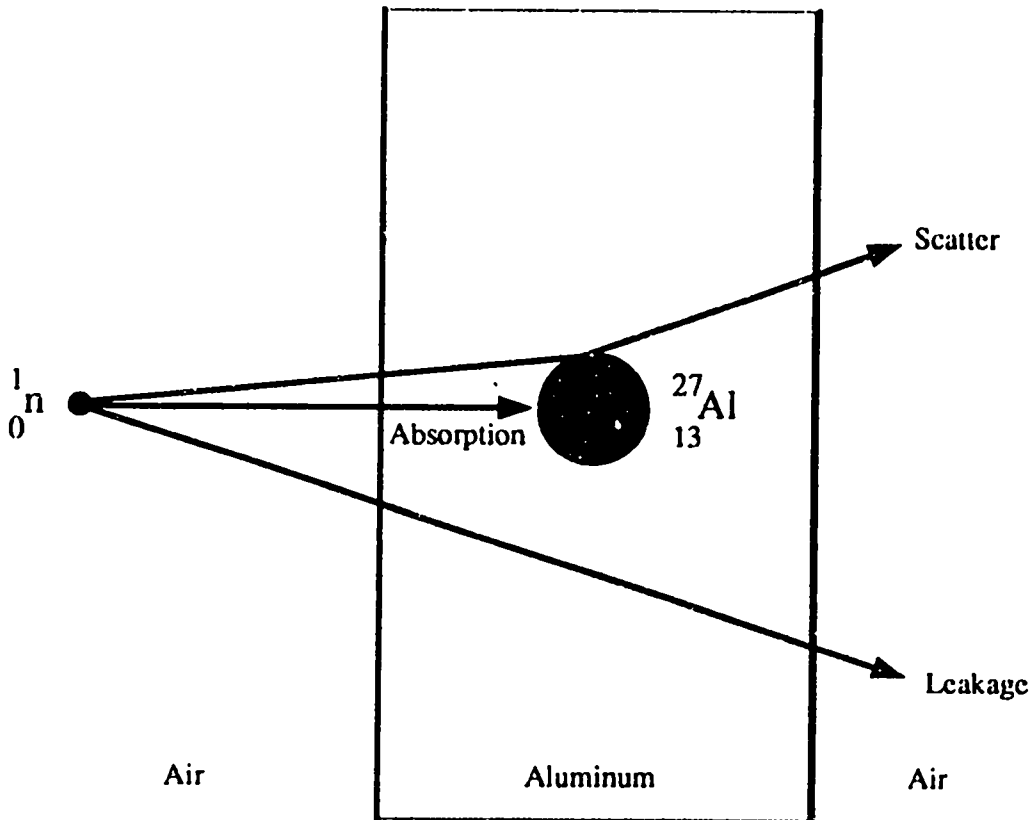

Figure 1. Basic neutron interaction modes.

During scatter, the neutron's direction and to some extent its energy (speed) change but continues on until finally the neutron is either absorbed or it leaks out of the slab. The absorption process captures or absorbs the neutron. The result of this absorption process is a new, radioactive form of aluminum with a nuclear mass of 28 units. But for our purposes the important fact is that a neutron was lost to the system forever. The subsequent radioactive decay of  ${}^{28}\text{Al}$  does not release a neutron but instead an electron. The absorption process is often represented in equation form as  ${}^1_0n + {}^{27}\text{Al} \rightarrow {}^{28}\text{Al}$ , where the plus sign (+) signifies absorption.

A simplistic description of the scatter and absorption processes may be to visualize the former as hard sphere collisions, e.g., a marble (the neutron) bouncing

off (scattering) a billiard ball (the nucleus of the aluminum atom), while the latter may be thought of as one sticky gumball (one that has been well chewed — the neutron) colliding with and sticking to (being absorbed by) a larger sticky gumball (again, the nucleus of the aluminum atom.) Strange as it may seem, the neutron-nucleus collision may behave like a marble bouncing off a billiard ball one time (i.e., scatter process) and then two sticky gumballs the next (i.e., absorption process).

Although one cannot be sure what the outcome of a particular neutron-nucleus interaction will be, all is not lost. Measurements, aided by theory, have been performed that have told us probabilities or likelihoods of particular modes of interaction per atom.

The various interaction processes have been both measured and theoretically predicted in terms of the probability of a particular event per target atom or in terms of the total probability of all interaction events per target atom. A near-universal name for these probabilities is the term cross section. The cross section (or probability) for a particular event is generally reported in units of barns (1 barn =  $10^{-24}$  cm<sup>2</sup>) and given the symbol sigma ( $\sigma$ ). For most interactions of interest to us, the cross section (per atom) generally lies within the range 0.001 to 1000 b, or  $10^{-27}$  to  $10^{-21}$  cm<sup>2</sup>.

Note that  $10^{-24}$  cm<sup>2</sup> is roughly equal to the geometric cross-sectional area subtended by the nucleus of an atom. However, the similarity ends there. Actual cross sections generally vary substantially:

- from material to material and isotope to isotope,
- with the energy (speed) of the incident neutron, and
- with the type of process (scatter, absorption).

Look at a few examples of cross sections shown in figures 2, 3, and 4. Although it is difficult to make generalizations about cross sections, two that are reasonably consistent are: the absorption cross section rises steeply at low neutron energies, and scatter cross sections are usually slowly varying and reasonably independent of the energy of the neutron.

# FISSION CROSS SECTIONS

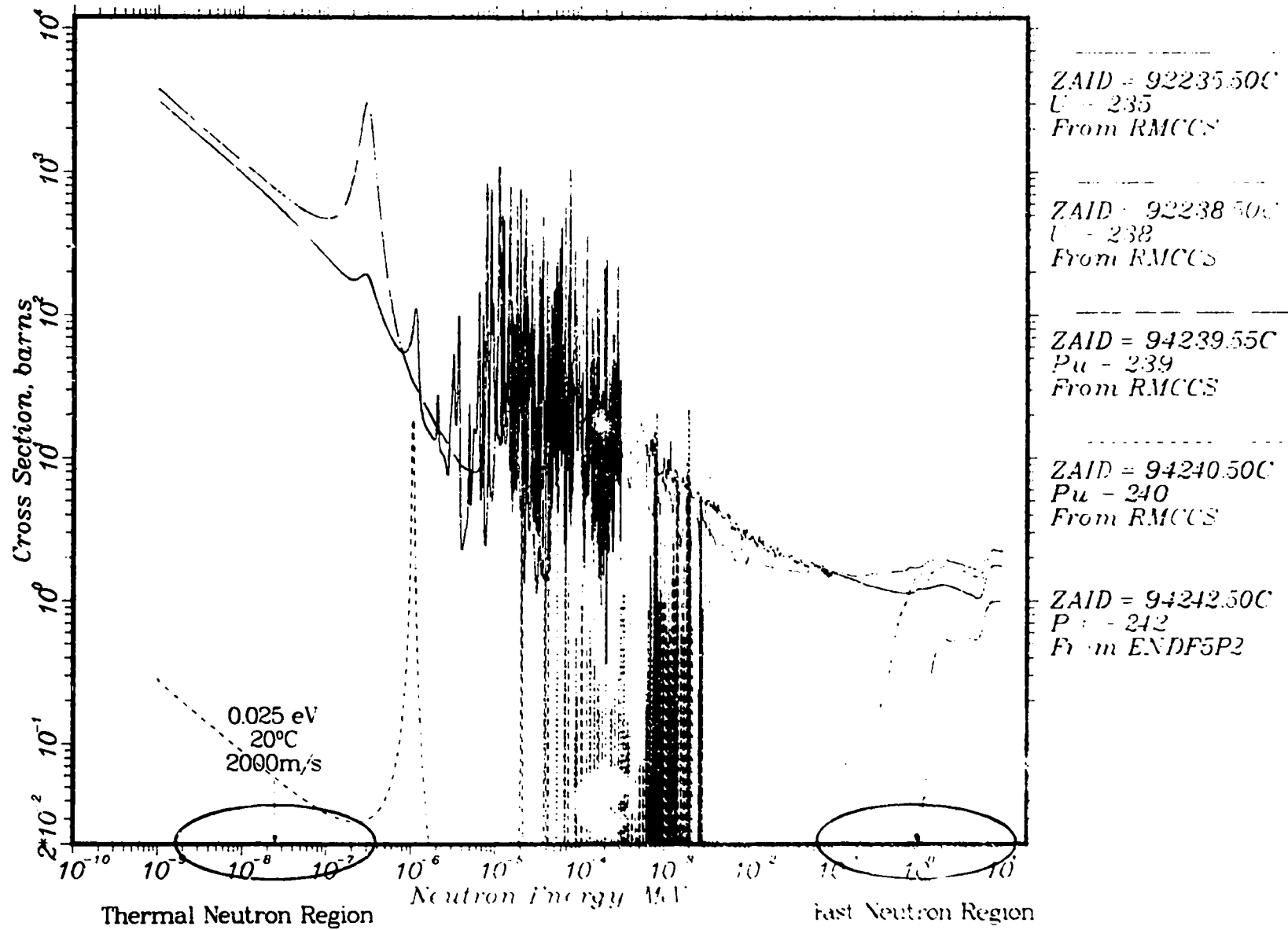

**Figure 2. Fission cross sections for selected isotopes.**

# SCATTER CROSS SECTIONS

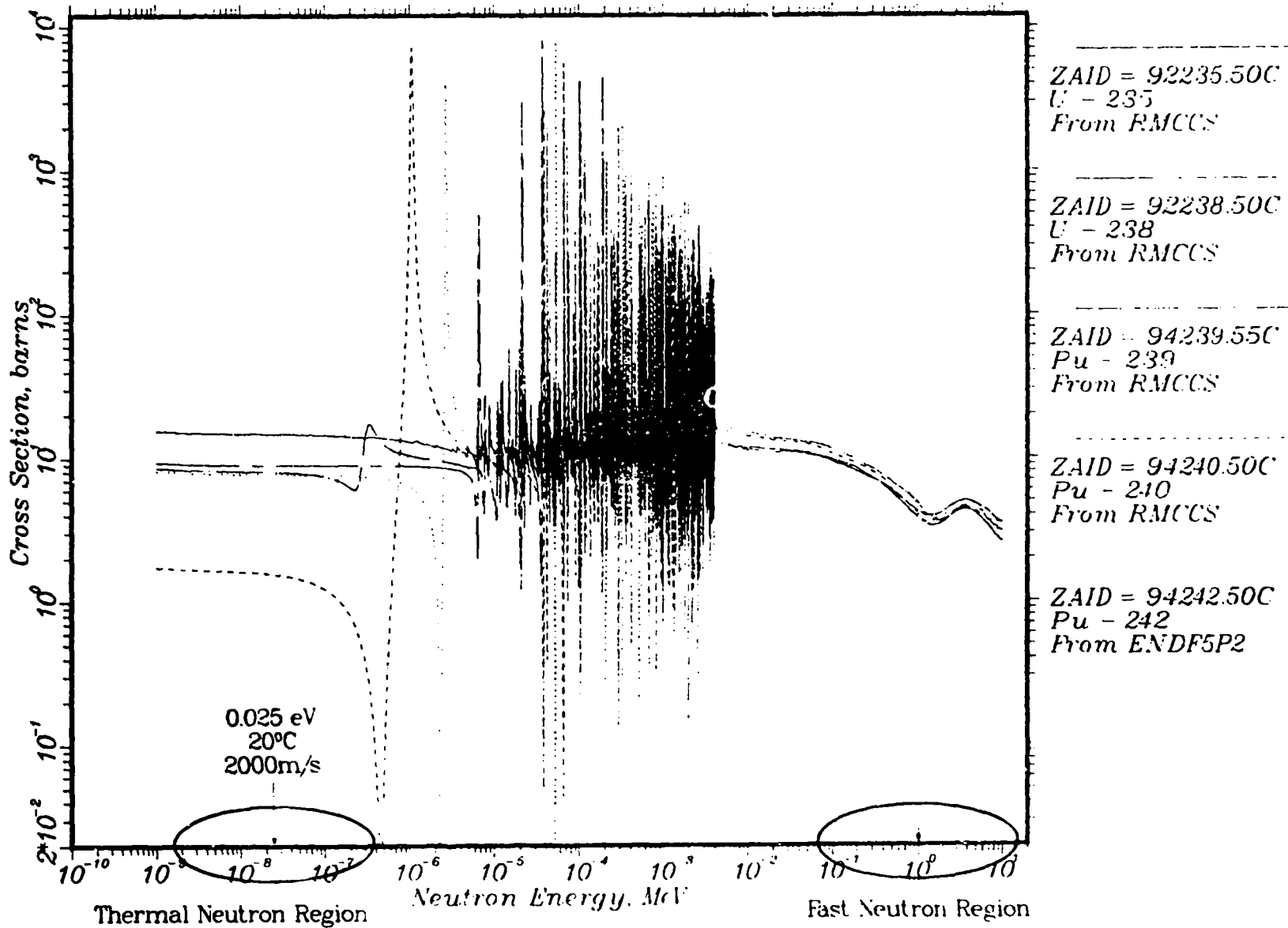
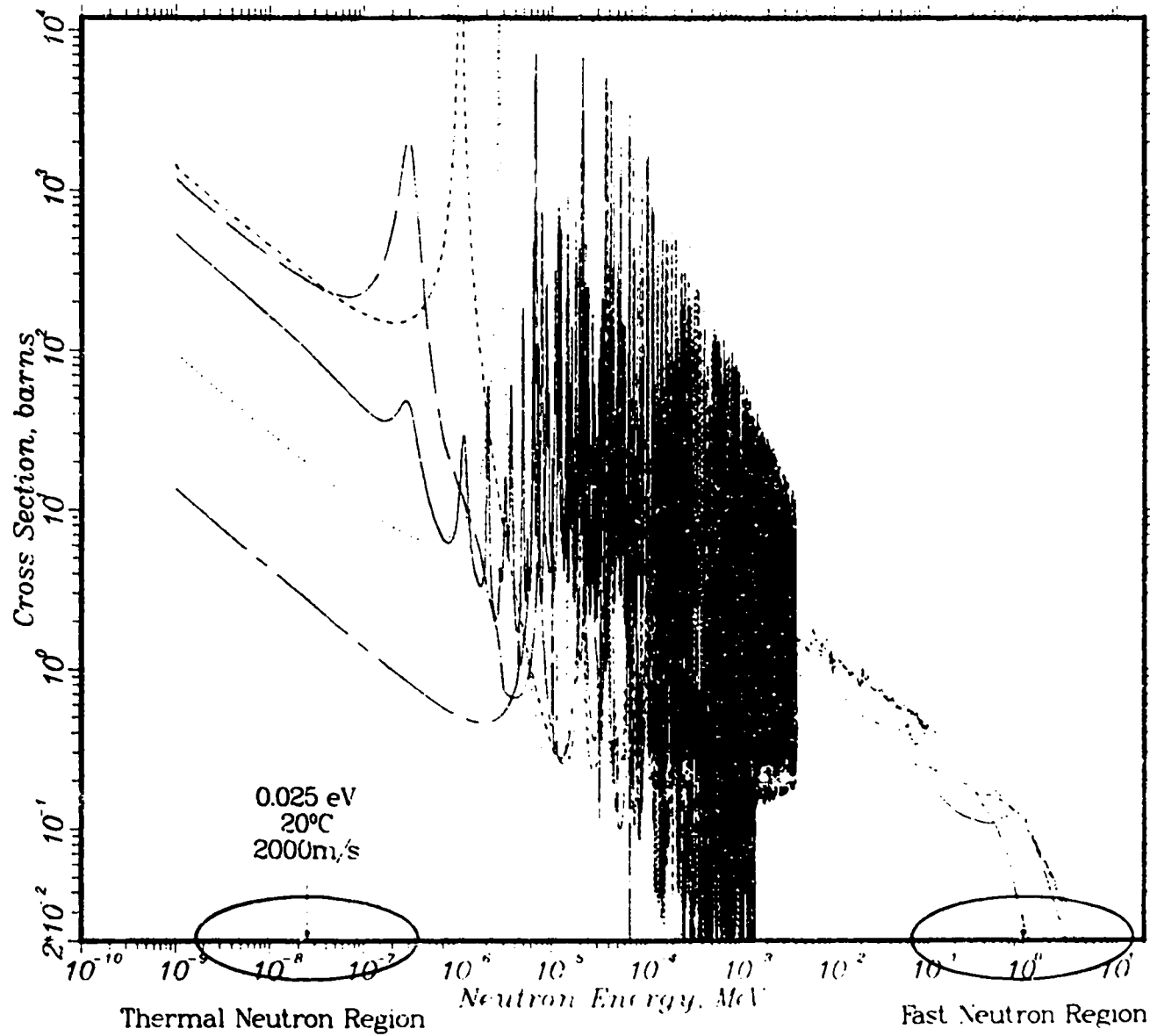

Figure 3. Scatter cross sections for selected isotopes.



# CAPTURE CROSS SECTIONS



ZAID = 92235.50C  
U - 235  
From RMCCS

ZAID = 92238.50C  
U - 238  
From RMCCS

ZAID = 94239.55C  
Pu - 239  
From RMCCS

ZAID = 94240.50C  
Pu - 240  
From RMCCS

ZAID = 94242.50C  
Pu - 242  
From ENDF5P2

**Figure 4. Capture cross sections for selected isotopes.**

The fission process, that has not been mentioned until now but is indicated on Figure 5 for  $^{235}\text{U}$ , is actually a subset of the absorption cross section for the heavy elements (uranium, plutonium, thorium and other heavy elements). For these heavy elements, the absorption cross section can be subdivided as:

$$\text{Absorption} = \text{Capture} + \text{Fission (heavy atoms only)}.$$

That is, the fission cross section is zero for all other (lighter in atomic mass) elements at neutron energies of interest.

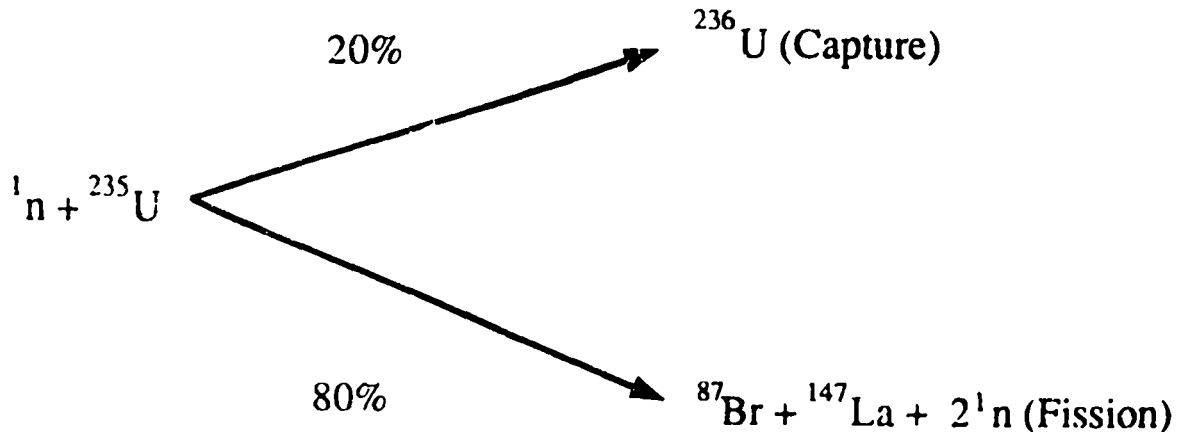

Figure 5. Neutron interaction with uranium.

The percentages shown indicate that roughly one time in five (20%) the absorption leads to a  $^{236}\text{U}$  atom, and the remainder of the time (80%) the neutron, upon being absorbed by the  $^{235}\text{U}$  nucleus, will cause the nucleus to immediately blow apart (fission). The products of this fission event are typically two rather heavy atoms, called fission fragments or fission products, and a few neutrons. The significant result of the fission event is the liberation of neutrons, which can then propagate the fission process in other  $^{235}\text{U}$  nuclei. This propagation is generally referred to as a chain reaction. Expressed differently, then, our goal in criticality safety is designing systems and planning operations such that fission events (which also occur naturally in uranium and plutonium) lead to chain reactions that die away with time rather than grow.

### A. NEUTRON ENERGY AND SPEED

Let us turn for a minute to the neutron's energy and its time of emergence subsequent to a fission event. Neutrons are "born", i.e., emerge from a split nucleus, as "fast" neutrons, and have energies in the 1-3 MeV (million electron-volt) range. The velocity of a 1-MeV neutron is ~13 million ( $1.3 \times 10^7$ ) meters per second (m/s). At normal room temperature ( $\sim 20^\circ\text{C}$ ), molecular motion energy is only 0.025 eV. If neutrons are slowed down (by way of collisions with other nuclei) to this energy, then their speed is reduced to ~2,000 m/s. That neutrons can be slowed down and the import of this fact to criticality safety will be made clear in subsequent sections.

## B. PROMPT AND DELAYED NEUTRONS

Nearly all neutrons that are born as a result of fission events appear essentially instantaneously. That is, within  $10^{-15}$  seconds after the fission event is detected, the neutrons may also be found (detected). These neutrons are known as *prompt* neutrons. The number of prompt neutrons which are released with any particular fission event may vary from 0 up to about 6, i.e., it has a statistical nature. But one can characterize the average number of prompt neutrons per fission by experimentally observing a large number of fission events. For the two most common fissioning species, these data are:

$$^{235}\text{U} \sim 2.5 \text{ neutrons per fission}$$

and

$$^{239}\text{Pu} \sim 3.0 \text{ neutrons per fission.}$$

These values depend slightly on the energy of the neutron that causes the fission, but this dependence is generally unimportant for criticality safety purposes.

A very small percentage of the time, however, a neutron may not be born until seconds or tens of seconds after the fission event has occurred. These neutrons arise from the radioactive decay of certain fission products and are known as *delayed* neutrons.

An example of delayed neutron emission is given (Fig. 6) by the decay scheme for  $^{87}\text{Br}$ . Note that the half-life for  $^{87}\text{Br}$  decay is 55 seconds and that not every decay proceeds from neutron emission. If the decay does follow the route  $^{87}\text{Br}$  to  $^{87}\text{Kr}$  (excited), however, then a neutron will appear almost simultaneously with the  $^{87}\text{Br}$  decay, because the half-life of the  $^{87}\text{Kr}$  (excited) is short compared to 55 seconds.

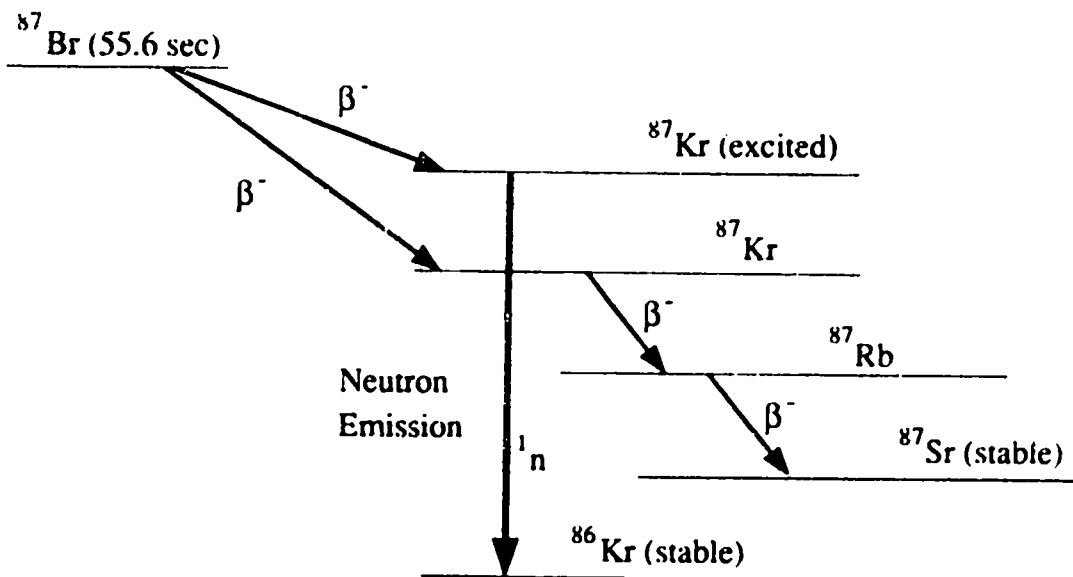

Figure 6. Example of delayed neutron emission.

The fractions of all neutrons born subsequent to the fission process which are prompt (and delayed) for  $^{235}\text{U}$  and  $^{239}\text{Pu}$  are as follows:

| Element           | Prompt | Delayed |
|-------------------|--------|---------|
| $^{235}\text{U}$  | 0.993  | 0.007   |
| $^{239}\text{Pu}$ | 0.997  | 0.003   |

These are average numbers which result from observing many fission events.

Although this relatively small fraction of neutrons that is delayed is generally not important in criticality safety considerations, it is *all important* in permitting *control* of the chain reaction, e.g., in controlling the fission rate in a reactor. Thus its significance will be discussed more fully later and emphasized in the experimental sessions when we actually run our critical assemblies (zero power) here at Pajarito Site.

#### IV. SIMPLE FISSIONING SYSTEMS

There are many forms in which fissionable material is processed, handled, used, etc. Examples are:

- solid metal (spheres, cubes, cylinders, slabs, etc.),
- ceramics ( $\text{UO}_2$ , UC, PuC,  $\text{UBe}_{100}$ ,  $\text{UC}_{1000}$  for reactor fuel),
- foils, turnings (from machining operations), and
- solutions (chemical reprocessing).

Although this list is not complete, for illustrative purposes let us consider two extremes: solid metal and hydrogenous solutions. That these are indeed extremes will be brought out later. Ceramics and foils generally possess the neutronic characteristics of solid metal systems; however, if the fissionable material is very dilute, e.g.,  $\text{UC}_{1000}$  or thin foils interspersed between layers of paraffin (hydrogenous), then the system has solution-like characteristics. The determining factor whether or not a system behaves neutronically like a solid metal or solution is the degree of dilution of the fissionable species ( $^{235}\text{U}$ ,  $^{239}\text{Pu}$ ) with other (usually light) atoms. Typical solutions contain H :  $^{235}\text{U}$  ratios of a few hundred to one. Obviously, there are systems that lie between these two simplified extremes of solid metal or solution, but knowledge of these two bounds will enable a reasonable understanding of any intermediate system, such as metal turnings in a waste container that was accidentally flooded with water or oil.

There is one further subdivision of these two limiting types of systems that is of interest. Again, for purposes of understanding basic processes and concepts, a system can be considered bare (not reflected) or reflected. The terminology here refers to whether neutrons upon leaving (leaking) from a fissioning system can scatter off surrounding material (actually the nuclei of the atoms thereof) and return to the fissioning system. Although in reality no system can be considered 100% unreflected, since even air will scatter some neutrons, it is convenient to consider this a limiting situation since many systems are for all practical purposes bare. Examples are the Godiva-IV and Jezebel assemblies at Pajarito Site and

reprocessing solutions in thin-walled tanks. Recall that the total interaction cross section is different for each material and is also dependent on neutron energy, but on the average, neutrons will travel from 1- to 10-cm in a dense material before interacting. Idealized systems of these four categories (solid metal and solution both bare and reflected) will be discussed individually in the following sections.

#### A. SOLID METAL — BARE

Although one generally must speak of average properties of a system, such as the average scattering cross sections or the average number of neutrons per fission, for a moment consider a single neutron and take the neutron's perspective as it travels in a system containing only uranium or plutonium atoms. Recall that a neutron travels only in straight lines between scattering events until it eventually leaks out of the system or is absorbed by a uranium (plutonium) nucleus. Looking at the scattering process on a relative basis, one realizes that since the uranium or plutonium nucleus is ~238 times as massive as the neutron, the situation may be likened to a fast moving marble striking a stationary billiard ball. The latter will not move perceptibly, while the former will bounce off in some direction with essentially the same speed it had before the scatter event.

Now, consider a system consisting of  $^{235}\text{U}$  metal pieces, e.g., on a bench and in a geometric arrangement such that the following averages characterize the system:

|                          |        |
|--------------------------|--------|
| Leakage probability      | = 0.5; |
| Absorption probability   | = 0.5; |
| Total "loss" probability | = 1.0. |

These system probabilities are not to be confused with the microscopic cross sections discussed previously. The distinction is that these system (average) probabilities are determined by both the microscopic cross sections and the physical arrangement of the system. As we mentioned earlier, the cross section is dependent only on the neutron's speed or energy for a given target atom, but obviously whether or not a neutron is absorbed in a 10-kg piece of pure  $^{235}\text{U}$  metal or leaks out clearly depends on the shape of the 10-kg of  $^{235}\text{U}$ . For example, as a dense sphere about the size of a grapefruit, there is a fair chance that a neutron will be absorbed by a  $^{235}\text{U}$  nucleus before leaking from the sphere. On the other hand, that same 10-kg uranium, when made into a thin foil 0.2-cm thick and 10-cm wide, would have a length of 535 cm. Clearly if this foil is laid flat (as opposed to being all coiled up like a watchspring), then a neutron born in the foil by natural radioactive decay will have essentially a 100% likelihood of leaking from the uranium. Note that a neutron may undergo many scatter events before leaking from the system boundaries, but for the purpose at hand, a scatter event is essentially a nonevent, since the neutron changes its direction only, not its energy (speed).

Following this example further, imagine a snapshot to be taken of the system at an instant in time that revealed 100 neutrons to be zipping around within the system boundaries. Although each individual neutron will either be absorbed or will leak out of the system at a slightly different time subsequent to the snapshot, the average lifetime of all the prompt neutrons from their time of birth to either absorption or leakage from the system can be thought of in much the same way we think of human lifetimes and generations.

With the given probabilities, how many second-generation prompt neutrons will arise from these 100 first-generation neutrons?

$$\text{Leak out} = 100 \times 0.5 = 50 \text{ neutrons}$$

$$\text{Absorbed} = 100 \times 0.5 = 50 \text{ neutrons}$$

This accounts for all of the first-generation neutrons; however, of those 50 that are absorbed there will result

$$\text{Capture} = 50 \times 0.2 = 10 \text{ neutrons,}$$

$$\text{Fission} = 50 \times 0.8 = 40 \text{ neutrons,}$$

and 40 fission events on the average will yield, 40 fissions  $\times$  2.5 neutrons per fission = 100 second-generation neutrons.

In this simplified example, the prompt neutrons have exactly reproduced themselves, and since we are neglecting delayed neutrons from the present discussion, this leads us to the definition of the multiplication factor and state of criticality.

$k \equiv$  multiplication factor

$\equiv$  number of fission neutrons in current generation divided by the number of fission neutrons in the previous generation.

For this example (and recall that delayed neutrons have been omitted from the discussion), the multiplication factor is

$$k = 100 \div 100 = 1.0 \text{ (critical)}$$

Additionally, if

$k < 1$ , the system is said to be subcritical, and if

$k > 1$ , the system is said to be supercritical.

With this simple system that is exactly critical, let us imagine that the average probabilities that characterize the system are suddenly changed to

$$\text{Leakage probability} = 0.4,$$

$$\text{Absorption probability} = 0.6,$$

$$\text{Total "loss" probability} = 1.0.$$

This sort of change could occur due to the addition of more material to that already present or merely rearranging the existing material (such as bringing pieces together) or due to a change in any other material near the uranium piece(s).

Now let us calculate the state of criticality of this system.

$$\text{Leak out} = 100 \times 0.4 = 40 \text{ neutrons}$$

$$\text{Absorbed} = 100 \times 0.6 = 60 \text{ neutrons}$$

As before, of those 60 that are absorbed by  $^{235}\text{U}$  nuclei there results

$$\text{Capture} = 60 \times 0.2 = 12 \text{ neutrons,}$$

$$\text{Fission} = 60 \times 0.8 = 48 \text{ neutrons,}$$

and on the average, 48 fission events will yield  $48 \text{ fissions} \times 2.5 \text{ neutrons per fission} = 120 \text{ second-generation neutrons}$  and

$$k = 120 \div 100 = 1.2 \text{ (supercritical).}$$

Thus we have made a physical change to our system that resulted in the multiplication factor going from 1.0 to 1.2, i.e., our system has changed from exactly critical to supercritical. The consequence of this is that whereas before the neutron level in our system was just maintaining itself, now with each generation the neutron population (and fission rate) is increasing by a factor of 1.2. The detailed implications of this  $k = 1.2$  on the actual rate of rise in the neutron population will be examined in Section V. Suffice it to say here that the fission rate will rise in much less than 1 second to a level such that overheating will occur, causing the fission rate to reduce itself, but only after a substantial number of fissions have occurred — accompanied by large (and possibly fatal) neutron and gamma-ray exposures to personnel in the immediate vicinity. Let us turn now to a second idealized system.

## B. SOLID METAL — REFLECTED

For this example imagine that a sphere of  $^{235}\text{U}$  was undergoing various mechanical tests in a generally unreflected geometry (i.e., on a bench). Then, due to a procedural mistake the sphere was inadvertently enclosed in a thick shell of some heavy-atom material (iron, lead, tungsten, etc.). The reason for specifying a heavy-atom reflecting material is so that neutron slowing down via scattering can be neglected.

Assume that in its unreflected state that the average probabilities characterizing the sphere are:

$$\text{Leakage probability} = 0.6$$

$$\text{Absorption probability} = 0.4.$$

The multiplication factor in this state is then,

$$k = 1.0 \times 0.4 \times 0.8 \times 2.5 = 0.8 \text{ (subcritical).}$$

Now, as a rule of thumb, a good reflecting material which completely enclosed a system can make as much as a factor of 2 change in the critical mass, which is defined as "that amount of material that will just sustain a chain reaction ( $k =$

1.0) for the stated conditions." For compact geometries, a factor of two change in the fissile mass corresponds roughly to a multiplication factor change of 25%. Thus, assume in the reflected state our probabilities are changed to

$$\text{Leakage probability} = 0.5$$

$$\text{Absorption probability} = 0.5$$

The multiplication factor has then changed to

$$k = 1.0 \times 0.5 \times 0.8 \times 2.5 = 1.0 \text{ (critical)}$$

Here we see that a system which was initially quite subcritical in its normal state,  $k = 0.8$ , became critical because of a postulated operational error. As a factor of two change in the mass of material required for critical is about the most that can be achieved in going from bare to well-reflected, for any system, operations are generally designed and planned such that for normal operating conditions  $k < 0.5$ . Then, in the event of an inadvertent reflection, such as a result of water flooding, the state of criticality, although it may increase by as much as 10 or 20%, will still be well below unity; that is, the system will be subcritical.

The two idealized systems we have just covered are often described as fast systems, the adjective referring to the velocity ( $\sim 1.3 \times 10^7$  m/s) of the neutrons that cause the majority of the fissions.

The next two systems to be discussed are often characterized as thermal systems since the velocity of the neutrons causing fission is about 2,000 m/s, which is the velocity of molecular motion at room temperature.

### C. SOLUTION — BARE

Although we often associate the word liquid with the definition of a solution, for our purposes we take the more general interpretation, which includes mixtures of solids and possibly gases. As we mentioned previously, the constituents need not be intimately mixed in order that the system have the neutronic characteristics of a solution. All that is necessary is that a neutron will typically scatter many times with diluent atoms for every interaction with a fissile atom. Examples are:

- plutonium nitrate (100 g/l Pu), H : Pu  $\sim$  250 : 1,
- uranium + beryllium mixture; Be : U  $\sim$  100 : 1, and
- 0.075-mm-thick uranium foils interspersed between 12.7-mm-thick Lucite plates.

The discussion that follows is restricted to solutions in which the diluent atoms have low atomic weights, i.e., the light atoms. This category generally includes atoms up to and including carbon ( $A = 12$ ). The distinguishing feature of these solutions is that fast neutrons may lose appreciable amounts of energy when scattering off the diluent atoms. Since there are many more diluent atoms than fissile atoms in a solution, there is a high likelihood that a fast neutron ( $\sim 1$  MeV) will scatter many times with the diluent atoms and thereby lose energy until the neutron finally attains an energy roughly equal to that of the atoms and molecules in the system. For a system at 20°C, this is 0.025 eV (2,000 m/s).



This neutron which has been moderated (thermalized) will now move about in the system until it either leaks out or becomes absorbed by one of the diluent nuclei or by a fissile nucleus. Although this is also exactly what fast neutrons do in a metal (unmoderated) system, there is a very important difference.

The relative cross sections of the nuclides — in particular the fissile nuclides — change dramatically with the energy of the neutron. Recall the figures depicting this dependence on the energy of the neutron (Figs. 2, 3, and 4). While the probability of a scatter event in  $^{235}\text{U}$  has stayed relatively constant over the entire energy range (10 MeV  $\rightarrow$  0.01 eV), the absorption cross section is  $\sim 100$  times greater for thermal neutrons than for fast neutrons. Thus, a thermal neutron is much more likely to be absorbed during any one interaction with a  $^{235}\text{U}$  nucleus than is a fast neutron. Put another way, the fast neutron is much more likely to scatter a few or perhaps many times and eventually leak out of the system than a thermal neutron, which will likely not scatter but be absorbed.

To illustrate the dramatic effect the thermalization of neutrons can have, consider the following, which compares the minimum critical  $^{235}\text{U}$  mass for bare spheres of uranium metal and solutions of uranium and water.

|                           | Metal | Solution |
|---------------------------|-------|----------|
| $^{235}\text{U}$ Mass, kg | 48.7  | 1.6      |

These numbers show a factor of 30 difference in the critical masses of these two systems. The uranium used in the calculations that yielded these results is standard Oralloy or U(93), that is, 93.2 wt%  $^{235}\text{U}$ ,  $\sim 5.8$  wt%  $^{238}\text{U}$ , and  $\sim 1$  wt%  $^{234}\text{U}$ .

If one were to perform calculations with uranium that was 100 wt%  $^{235}\text{U}$  then these values would be reduced slightly. Conversely, as the  $^{235}\text{U}$  fraction of the uranium is reduced, the critical mass increases rapidly. As a final example of an idealized system, consider fissile material reflected by a low-atomic-mass material.

#### D. METALS OR SOLUTIONS REFLECTED BY MATERIALS OF LOW ATOMIC MASS ( $A \leq 12$ )

This system introduces nothing new in the way of basic concepts or processes. The significance of considering this system is linked directly to criticality safety. As has been previously mentioned, the critical masses of bare systems are potentially as much as twice as large as the critical masses of well-reflected systems. Put another way, if a bare system has a multiplication factor of  $\sim 0.8$  and it is inadvertently (accidentally) reflected, the increase in the multiplication factor may be sufficient for  $k$  to exceed unity.

System changes that lead to undesired increases in the state of criticality are designed against, if they are recognized *a priori* and if considerations of the likelihood of occurrence and the cost and inconvenience associated with the design changes warrant it. A typical example of a consideration that is always given to bare systems is the possibility of flooding, i.e., reflection by water. This is because water is a good reflector, and it can completely surround the system in question easier than any solid material could. Events such as roof leaks, water pipe ruptures, and drain plugging can and do happen. On the other hand, reflection by some solid materials can lead to increases in the multiplication factor even greater than water reflection can, but this would nearly always require gross procedural and human factors errors in judgment and generally could not occur accidentally.

## V. TIME BEHAVIOR OF FISSIONING SYSTEMS

During routine operations involving fissile materials (excluding reactors), the multiplication factor is held far below unity. If the multiplication factor is changed, then the rate of occurrence of fissions will also change. In analyzing this temporal behavior from a practical criticality safety standpoint, only prompt neutrons need be considered. However, to provide a more thorough groundwork, especially for the experiments to be conducted during this course, let us examine the importance of delayed neutrons in controlling the fission rate (i.e., power level) in systems that are intentionally brought almost to or slightly in excess of a critical state ( $k = 1.0$ ).

Consider the possible range of  $k$  for uranium and plutonium systems, as indicated in Figure 7. The upper limit on  $k$  is only approximate and can never be achieved in reality. It is of no practical consequence to criticality safety.

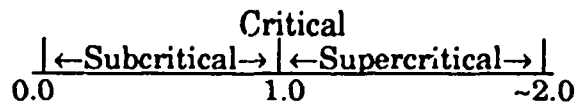

Figure 7. Multiplication factor,  $k$ .

To show that delayed neutrons need not be considered, in general, for criticality safety purposes, we may separate the multiplication factor into components,

$$\begin{aligned}k &= (1 - \beta)k + \beta k \\ &= k_p + k_d\end{aligned}$$

where  $k_p$  = the prompt multiplication factor =  $(1 - \beta)k$  and  $k_d$  = the delayed multiplication factor =  $\beta k$ .

Recall that the delayed neutron fraction,  $\beta$ , is only 0.007 for  $^{235}\text{U}$  or 0.003 for  $^{239}\text{Pu}$ , thus  $k_p = (1 - \beta)k = k$ , which clearly shows that if the system is accidentally made supercritical,  $k > 1$ , then in all likelihood, a super-prompt critical state,  $k_p > 1$ , will also be reached.

Let us emphasize this point with two examples:

Case 1:  $k = 1.1$ , or, the multiplication factor exceeds that for critical by 10%. Now,  $k_p = (1 - 0.007)(1.1) = 1.092$ , and the system is supercritical on prompt neutrons alone.

Case 2:  $k = 1.01$ , or the multiplication factor exceeds that for critical by only 1%! Now,  $k_p = (1 - 0.007)(1.01) = 1.003$ . Note that even for a system that is only 1% supercritical, the system is still supercritical on prompt neutrons alone.

Now let us turn to the time dependence of the prompt neutron population during a criticality accident ( $k_p > 1$ ).

It can be shown that the rate of change of the prompt neutrons in a system is given by

$$n(t) = n_0 e^{(k_p - 1)t} \quad (1)$$

for an abrupt (step) change in  $k_p$ , where

- $n_0$  = neutron level before the change in  $k$ ,
- $k_p$  = prompt multiplication factor after the change in  $k$ ,
- $l$  = average lifetime of prompt neutrons in the system,
- $t$  = time, referenced to  $t = 0$  at the time of the change in  $k$ , and
- $e$  = base of natural logarithms = 2.718.....

For unmoderated (fast) systems, the prompt neutron lifetime is in the range

$$10^{-9} < l < 10^{-5} \text{ seconds,}$$

and for well moderated systems,

$$10^{-4} < l < 10^{-3} \text{ seconds.}$$

Systems that are only weakly moderated, e.g.,  $5 < H : U < 50$ , would have average prompt neutron lifetimes between these bounds.

Although the prompt neutron lifetime is as much as 100,000 times longer in a thermal system than in a fast system, the important point is that the lifetime is short by comparison to human reaction times for all fissioning systems! Some examples will make the significance of this clearer.

Consider an abrupt change in  $k$  from any subcritical state to a  $k_p$  of 1.1. According to Eq. (1) the prompt neutron population will increase as

$$n(t) = n_0 e^{(1.1)t/l}.$$

For the two extremes,  $l = 10^{-3}$  and  $l = 10^{-5}$  s, how much will the original neutron level have increased in only 0.1 second, in 0.2 seconds, and 1.0 second?

For  $l = 10^{-3}$

$$n(0.1) = n_0 e^{10} = 22,000 n_0$$

$$n(0.2) = n_0 e^{20} = 485,000,000 n_0$$

For this slow system, the neutron population [and thus the fission rate and the radiation (neutron and gamma) level in the vicinity of the system] has increased nearly a billion-fold in only two-tenths of a second. And, at

$$n(1.0) = n_0 e^{100} = 3 \times 10^{43} n_0$$

This value could never be reached because overheating or other natural mechanisms would reduce the multiplication factor below prompt critical, but only after a large release of radiation (in much less than one second).

For  $l = 10^{-5}$ ,

$$n(0.1) = n_0 e^{1,000,000}$$

$$n(0.2) = n_0 e^{2,000,000}$$

and,

$$n(1.0) = n_0 e^{100,000,000}$$

How would this situation have been modified if the hypothetical accident had led to a state of criticality only slightly supercritical, say  $k = 1.01$ ? Since  $k_p = (1 - \beta)k$ , let us assume the system is uranium bearing, for which  $\beta = 0.007$ ; then  $k_p = 1.01$ .

Now, in one second the neutron population will rise to:

$$\text{For } t = 10^{-3}, n(1.0) = n_0 e^{10} = 22,000 n_0.$$

$$\text{For } t = 10^{-8}, n(1.0) = n_0 e^{1,000,000}!$$

Thus even for states of criticality only slightly supercritical and even for very thermal systems with relatively long prompt neutron lifetimes, the fission rate and neutron population will increase on a time scale that will result in the excursion terminating itself before human reactions have a chance to influence the outcome. These nuclear excursions will result in little or no mechanical damage to the fissioning system in almost all cases; however, the radiation exposure to nearby personnel can be, and in a few instances has been, lethal.

### INFLUENCE OF DELAYED NEUTRONS

Before we consider the importance of those relatively few delayed neutrons, let us introduce some nomenclature. We have previously defined the point,  $k = 1$ , as critical. This point is also known as delayed critical, implying that the system is critical with the inclusion of delayed neutrons. When  $k = 1 + \beta$ , then  $k_p = 1$  and this point is known as prompt critical, implying that the system is critical on prompt neutrons alone. Finally, when one operates systems (e.g., reactors) in the vicinity of  $k = 1$ , then fine reactivity control is required, and the unit of reactivity most common for expressing small changes in the state of criticality is the *dollar* unit, defined by  $1 \$ = \beta$ . Note that the dollar is different for uranium and plutonium systems (0.007 vs. 0.003), but in all cases, it is the reactivity difference between delayed critical and prompt critical. The nomenclature is illustrated in Figure 8. A further subdivision of the reactivity scale is sometimes used for small reactivity changes, that is, the *cent*, and as for the monetary system, 100 cents = 1 dollar, or 1 cent = 0.01 \$.

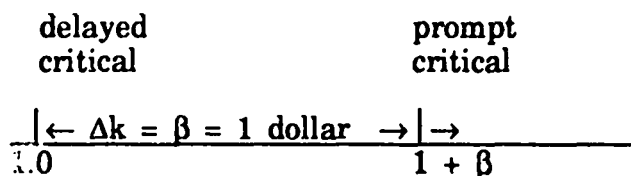

Figure 8. Delayed and prompt multiplication factors.

Now, during routine reactor operations, the state of criticality is brought to slightly supercritical, temporarily, when power-level increases are desired. For example,  $k$  is changed from 1.0 to 1.001 (note that  $k_p$  is still less than unity). At this slightly supercritical state, the neutron population will increase but on a time scale dominated by the delayed neutrons and not by prompt neutrons. That is, the increase will occur on a second or minute time scale instead of on a millisecond or microsecond time scale. This change is sufficiently slow that either automatic or manual control of the neutron level or fission rate is easily accomplished.

Consider the realistic example of  $k$  being changed from 1.0 to 1.001 for a uranium-fueled reactor ( $\beta = 0.007$ ). The neutron level would increase by a factor of 2.718 ( $e$ ) in about 86 seconds. One would characterize the state of criticality by stating that the system is 0.143 \$ or 14.3 cents above critical and is on an 86-second period, the period being the time required for the system power level or neutron level to increase by a factor of  $e$ . After the desired power level has been attained, then the control mechanism(s) would be reset such that  $k$  would again equal unity and the power would remain constant thereafter.

It bears reiterating that this reactivity span between delayed and prompt critical ( $\beta = \Delta k$ ), very small in absolute units, is more than sufficient for the control of reactors, as will be demonstrated during the course. On the other hand, as  $\beta$  is so small on an absolute basis compared to possible accidental changes in the state of criticality ( $\Delta k \sim 0.2$ ), it is of almost no consequence to criticality safety.

## VI. FACTORS INFLUENCING CRITICALITY AND PRACTICAL EXAMPLES OF CRITICALITY CONTROL

In the first part of the course, many fundamental concepts were introduced and explained through the use of idealized systems. Those fundamental concepts will be related as practical criticality safety examples to storage and handling operations with fissile materials, particularly here at the Los Alamos National Laboratory. Additionally, the ten factors listed below are highlighted with examples. In combination with administrative controls, they provide the criticality control for all process operations.

- mass
- density
- shape
- volume
- concentration
- moderation
- reflection
- poisons
- enrichment
- interaction

### A. MINIMUM CRITICAL MASSES AND SIZES

In this section, critical data and critical masses and sizes derived from experimental measurements are provided and discussed.

Let us examine and explain the critical mass curve for  $^{235}\text{U}$  as shown in Figure 9. Here the critical  $^{235}\text{U}$  mass of a spherical U(93) system is plotted as a function

of the  $^{235}\text{U}$  density; the diluent is water, which is assumed to be uniformly distributed in the system for U(93) densities at less than full density (17.5-kg  $^{235}\text{U}/\text{l}$  or the equivalent 18.7-kg U(93)/l). Curves for water-reflected and thin-steel-reflected (essentially bare) systems are drawn. Consider the lower of the two curves in the following discussion.

Starting from the fully dense, water-reflected system at 22 kg/l and 17.5 kg/l, the critical  $^{235}\text{U}$  mass increases slightly as water is added uniformly to the system. The addition of water molecules initially has the overriding effect of pushing the uranium atoms farther apart, thereby enhancing neutron leakage. The effects of neutron moderation, i.e., thermalization (or slowing down), and absorption by the hydrogen nuclei, are relatively unimportant at such low H : U ratios. Proceeding to slightly lower  $^{235}\text{U}$  densities, the curve reaches a maximum at about 23 kg. At this point, neutron moderation has offset the leakage effect.

As the  $^{235}\text{U}$  is further diluted with water, the moderation effect continues to dominate until the critical mass reaches a minimum of about 800 g at a  $^{235}\text{U}$  concentration of approximately 50 g/l. Note that up to this point even though the critical mass has been decreasing, the system volume has been increasing. Thus, on a relative scale, the system leakage has been decreasing.

At this minimum, the system has a volume of

$$800 \text{ g} \div 50 \text{ g/l} = 16 \text{ liters.}$$

This corresponds to a sphere ~31-cm in diameter, exclusive of the reflector. Increases in the water content of the system at this point cause the critical mass to rise sharply. What is happening is that the system is "over moderated," that is, neutrons are readily slowed down to thermal energies by the high H : U ratio but the absorption by hydrogen nuclei is now becoming excessive. Put another way, the uranium atoms are becoming so spread out and dilute that the neutrons are no longer interacting sufficiently with them before being absorbed by the hydrogen nuclei. Finally, if the  $^{235}\text{U}$  density falls below about 11 g/l then the system could be made infinitely large and still not be able to attain  $k = 1$ .

From the above discussion, if one would locate 50 g/l on Figure 10 and go up until the water-reflected curve is intersected, the corresponding critical volume at this point would be about 16 liters. This is in agreement with the previous determination of the critical volume using mass and concentration.

The above discussion for the uranium data (Figs. 9 and 10) applies equally to the plutonium data (Figs. 11 and 12). Note that for plutonium, its initial rise in the mass required for critical (as dilution with water commences) is much more pronounced than for highly enriched uranium; the critical plutonium mass at an H/Pu of 5 is about twice the critical mass of the metal at full density. Also, the effect of the  $^{240}\text{Pu}$  isotope and some nitrates is very pronounced in solution systems, as indicated. This is due to the large absorption cross section of  $^{240}\text{Pu}$  for slow neutrons. This effect is much smaller for highly enriched uranium since the  $^{238}\text{U}$  absorption cross section is much smaller than that of  $^{240}\text{Pu}$ .

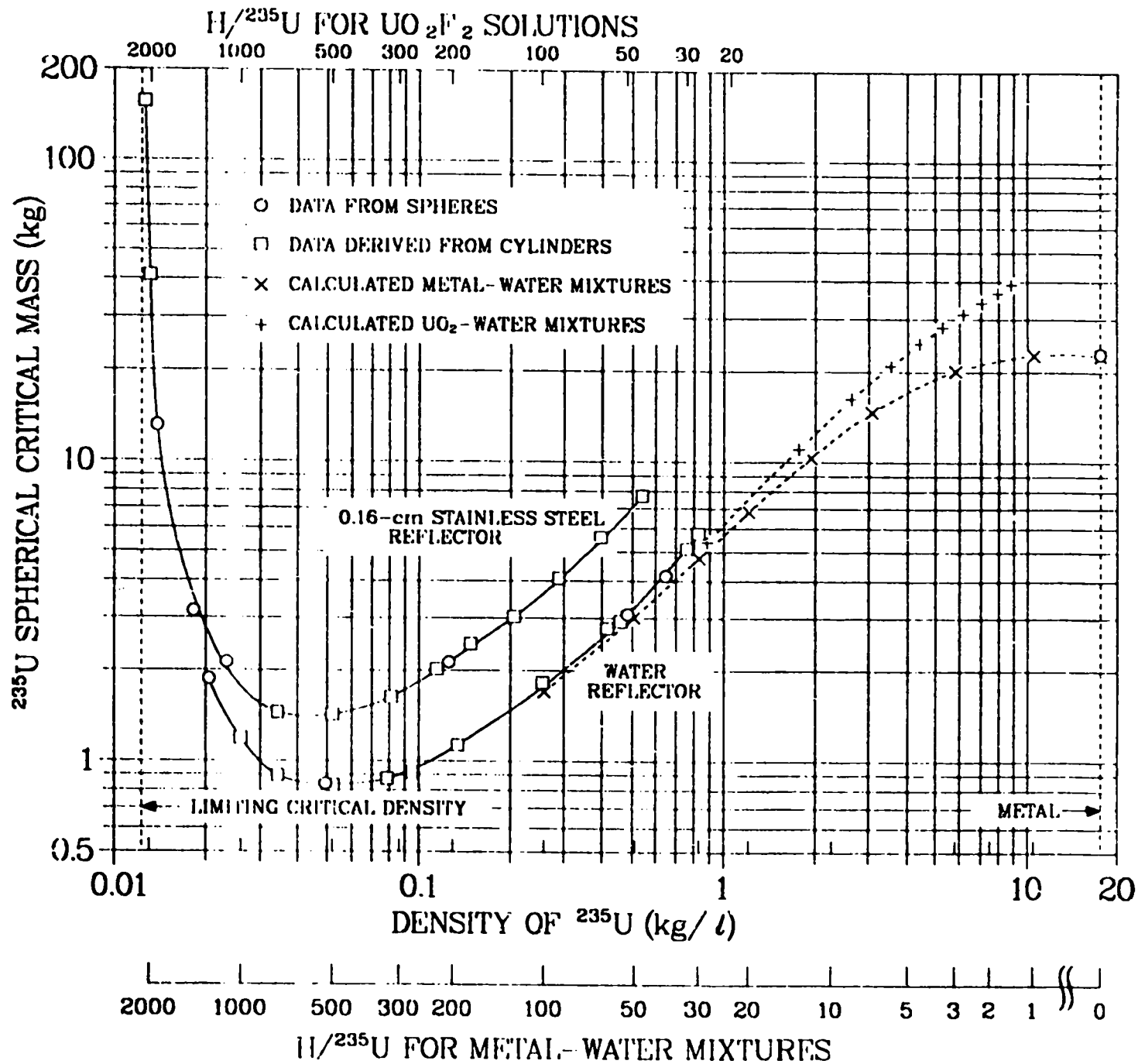

**Figure 9. Critical masses of homogenous water-moderated U(93.2) spheres. Solution data appear unless indicated otherwise. (From LA-10860-MS, Figure 10).**

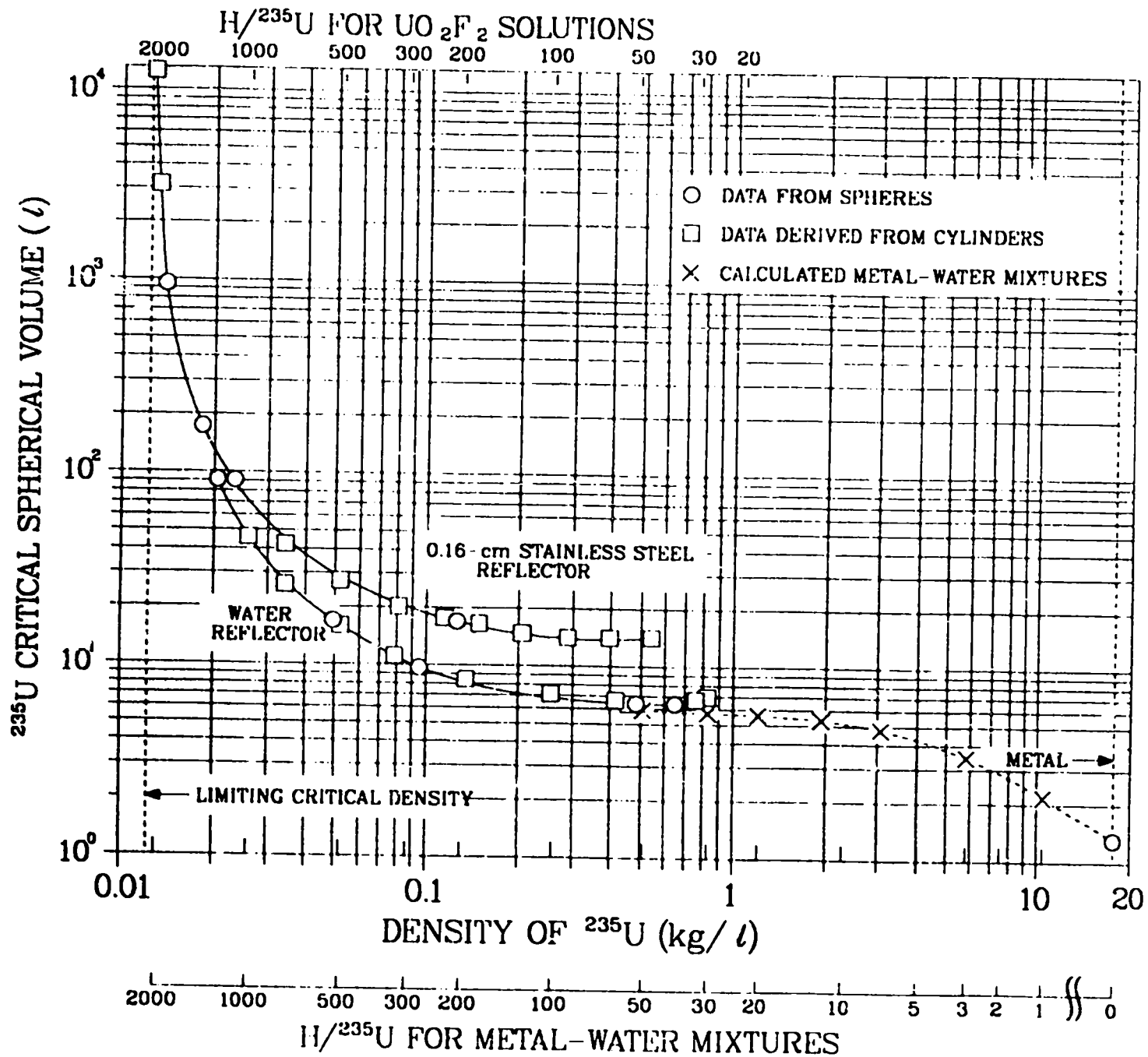

Figure 10. Critical volumes of homogenous water-moderated U(93.2) spheres. Solution data appear unless indicated otherwise. (From LA-10860-MS, Figure 11).



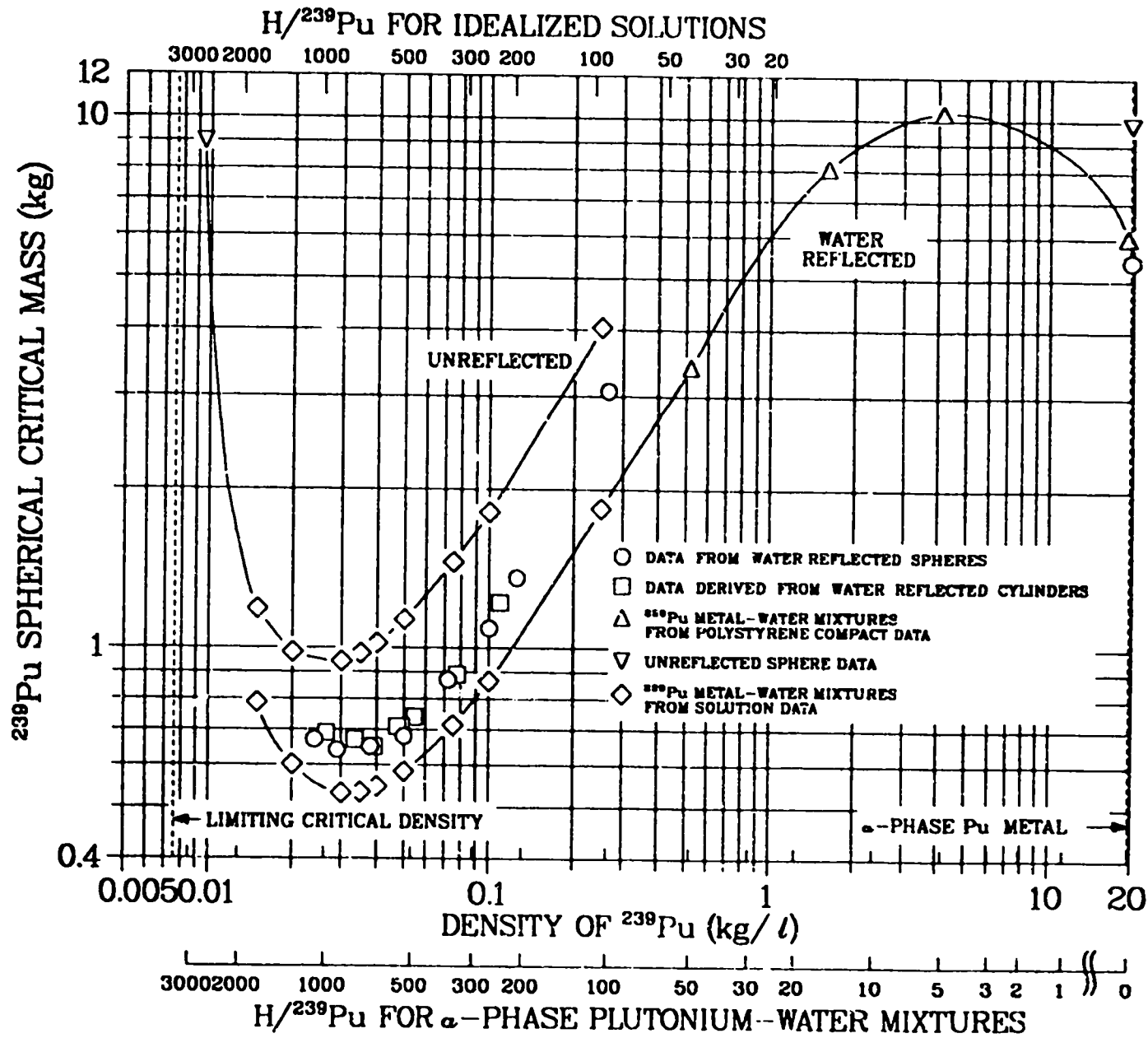

Figure 11. Critical masses of homogeneous water-moderated  $^{239}\text{Pu}$  spheres. The points suggesting an intermediate curve apply to water-reflected  $\text{Pu}(\text{NO}_3)_4$  solutions with 1 N  $\text{HNO}_3$  and 3.1%  $^{240}\text{Pu}$  content of the plutonium. (From LA-10860-MS, Figure 31).

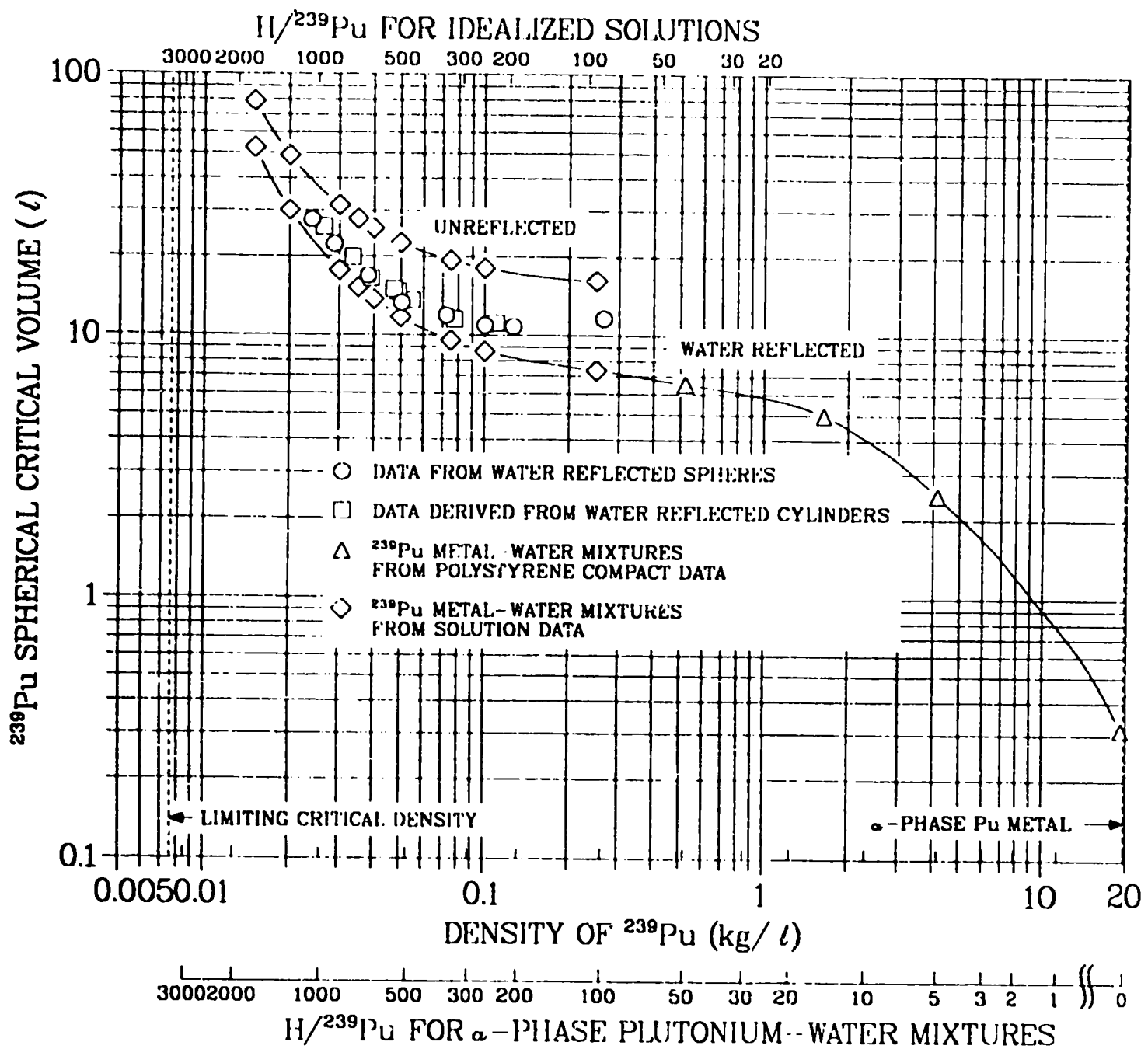

Figure 12. Critical volumes of homogeneous water-moderated  $^{239}\text{Pu}$  spheres. The points suggesting an intermediate curve apply to water-reflected  $\text{Pu}(\text{NO}_3)_4$  solutions with 1 N  $\text{HNO}_3$ , and 3.1%  $^{240}\text{Pu}$  content of the plutonium. (From LA-10860-MS, Figure 12).

## 1. MINIMUM CRITICAL MASSES OF COMMON MATERIALS

The minimum critical masses of bare- and water-reflected spheres of common fissioning materials for both solid metal and solution (water-base) systems are as follows:

---

### MINIMUM CRITICAL MASSES (SPHERICAL GEOMETRY)

| <u>Material</u>                 | <u>Metal* (kg)</u> |                  | <u>Solution* (g)</u> |                  |
|---------------------------------|--------------------|------------------|----------------------|------------------|
|                                 | <u>bare</u>        | <u>reflected</u> | <u>bare</u>          | <u>reflected</u> |
| Pu** (alpha phase)              | 10.2               | ~5.8 }           | 1000                 | 500              |
| Pu (delta phase)                | 15.6               | ~8 }             |                      |                  |
| U(93) (oralloy)                 | 50                 | ~25              | 1600                 | 800              |
| <sup>235</sup> U                | ~16.1              | ~8               | 1000                 | 500              |
| <sup>238</sup> Pu               | ~8                 | ~7               |                      |                  |
| <sup>238</sup> PuO <sub>2</sub> | ~21                |                  |                      |                  |
| <sup>242</sup> Pu               | ~80                |                  |                      |                  |
| <sup>241</sup> Am               | 100 - 200          |                  |                      |                  |
| <sup>243</sup> Am               | 150 - 2000         |                  |                      |                  |

\* Solutions are idealized metal-water mixtures; reflector is thick water, i.e., ~10-cm.

\*\* Pu is nominal weapons grade: 95% <sup>239</sup>Pu + 5% <sup>240</sup>Pu.

---

Departures from spherical geometry will, for all practical purposes, always decrease the state of criticality, i.e., reduce *k*. This is because a sphere has the minimum surface-area-to-volume ratio of any geometry, and as the ratio increases, so does neutron leakage. For example, a critical, water-reflected, alpha-phase plutonium sphere is about the size of a baseball. If this same amount of material were formed into a cylinder 1-cm in diameter, it would be 3.82-m long. This 5.5-kg cylindrical system would be far subcritical (*k* < 0.1) because the surface area (for neutron leakage) is about 30 times that of the same mass (and volume) sphere.

The important point to be made here is that much more material than the critical masses given in this table can be and sometimes is stored, processed, or handled in "high leakage" geometries for reasons of economy and practicality. Material stored in extended geometries should never be transferred to more compact containers unless the operation has been thoroughly investigated in advance.

## 2. MINIMUM CRITICAL SIZES OF CYLINDERS AND SLABS

In reality, systems are always of finite extent; however, for all practical purposes, the 1-cm-diameter x 3.82-m-long cylinder of alpha-phase plutonium described previously would be an infinite cylinder. In this context, infinite implies that essentially all of the neutron leakage is from the curved surface and essentially zero from the ends of the cylinder. For example, the surface area (neutron leakage area) ratio for this cylinder is

$$\frac{\text{Area curved surface}}{\text{Area both ends}} = \frac{\pi(1)(382)}{\pi(0.5)^2(2)} = 764.$$

Thus, if the neutron population within the cylinder were distributed uniformly over its volume, then for every neutron leaking from the ends of the cylinder about 764 neutrons would leak from the curved surface.

Minimum diameters and thicknesses for infinite, critical cylinders and slabs are as follows.

---

### MINIMUM CRITICAL SIZES

| <u>Material</u>               | <u>Infinite Cylinder<br/>Diameter, cm*</u> | <u>Infinite Slab<br/>Thickness, cm*</u> |
|-------------------------------|--|---|
| U(93) metal                   | 7.5 (11.5)                                 | 1.3 ( 5.5)                              |
| <sup>239</sup> Pu alpha metal | 4.6 ( 6.0)                                 | 0.8 ( 2.7)                              |
| U(93) solution                | 14.2 (21.5)                                | 5.0 (12.5)                              |
| <sup>239</sup> Pu solution    | 13.0 (21.0)                                | 5.0 (12.0)                              |

---

\*Thick water reflected and unreflected (bare) dimensions.

---

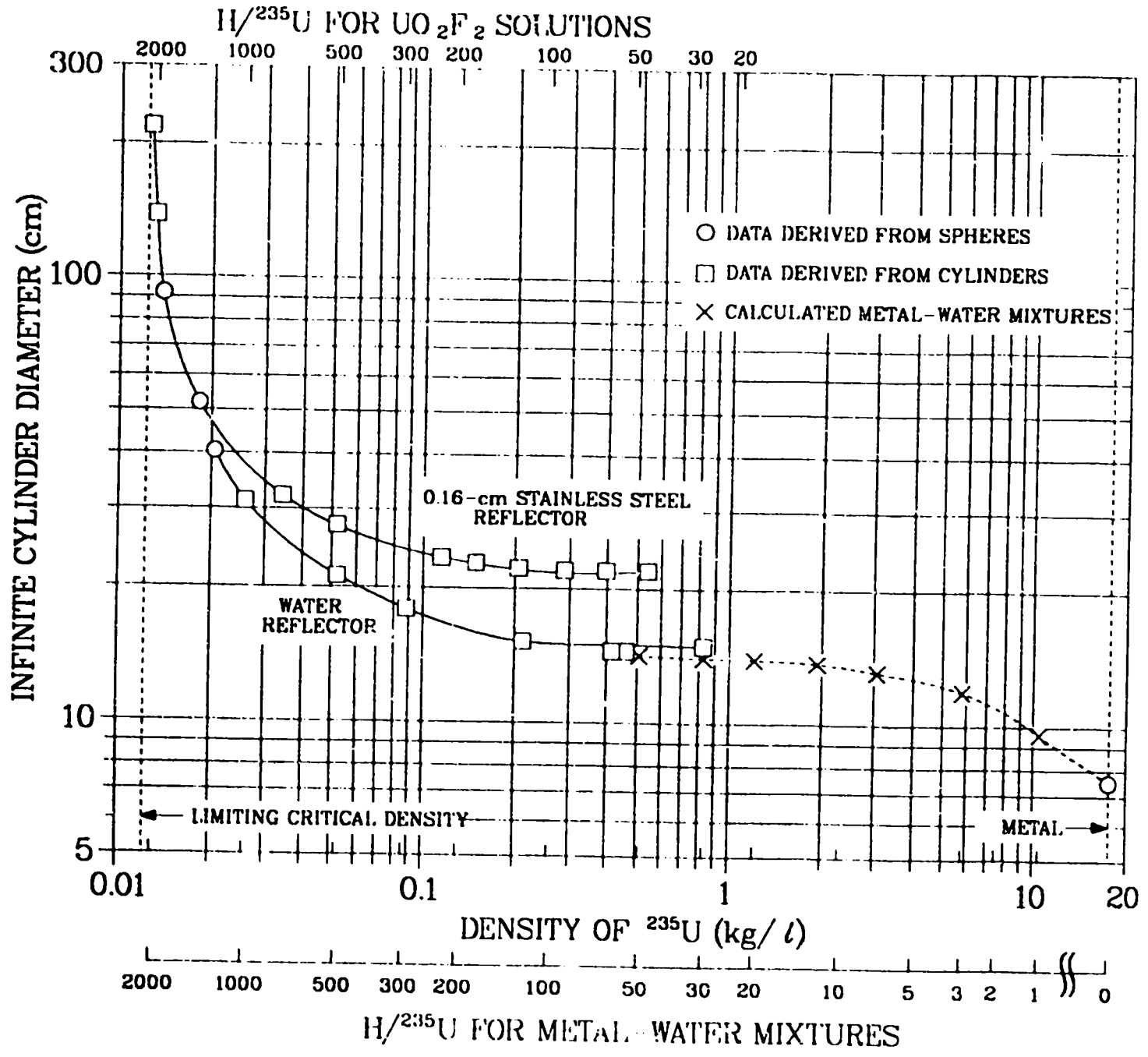
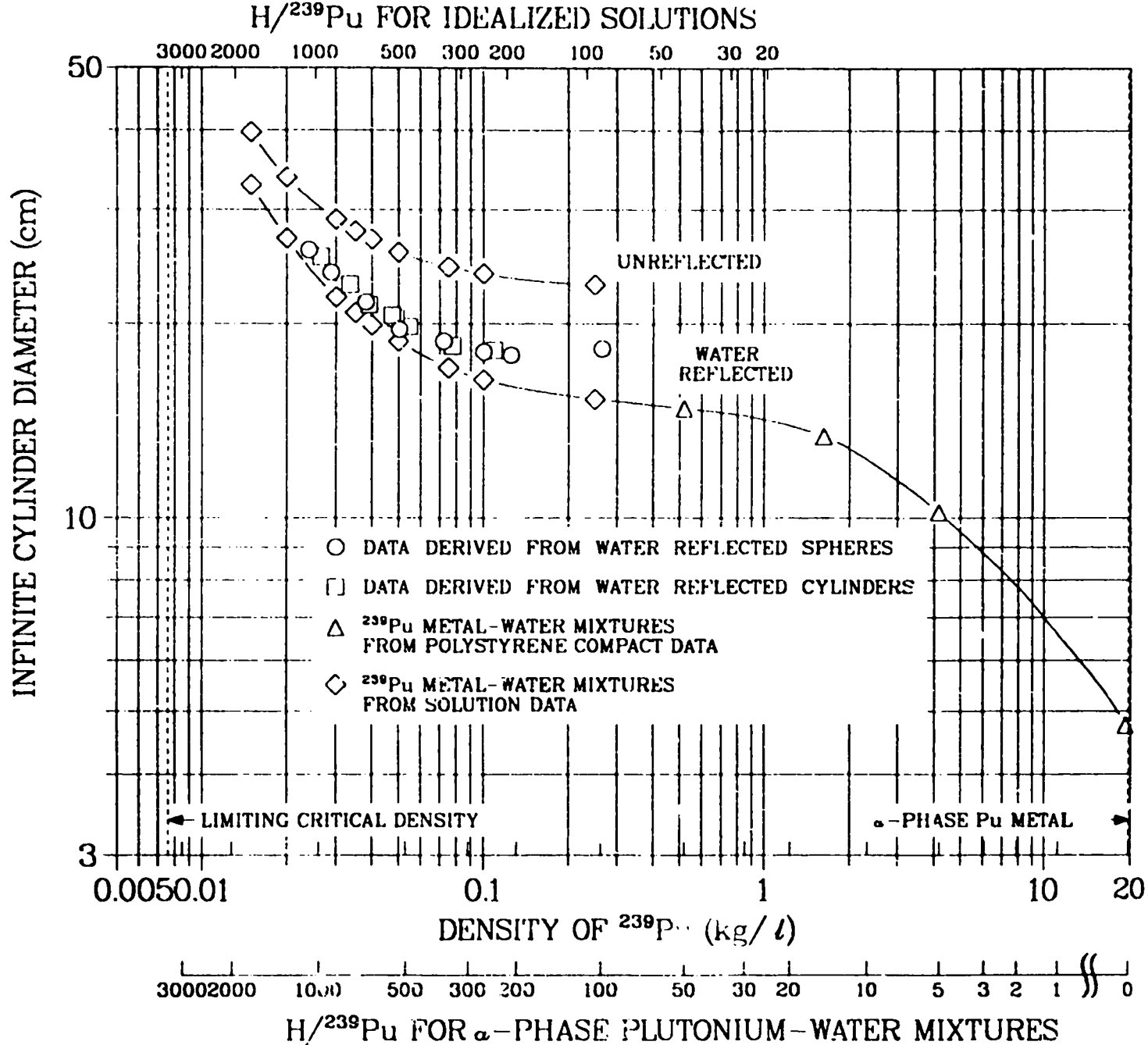

Figure 13. Estimated critical diameters of infinitely long cylinders of homogenous water-moderated U(93.2) spheres. Solution data appear unless indicated otherwise. (From LA-10860-MS, Figure 12).



**Figure 14.** Estimated critical diameters of infinitely long cylinders of homogeneous water-moderated  $^{239}\text{Pu}$ . The points suggesting an intermediate curve apply to water-reflecting  $\text{Pu}(\text{NO}_3)_4$  solutions with 1 N  $\text{HNO}_3$  and 3.1%  $^{240}\text{Pu}$  content of the plutonium. (From LA-10860-MS, Figure 33).

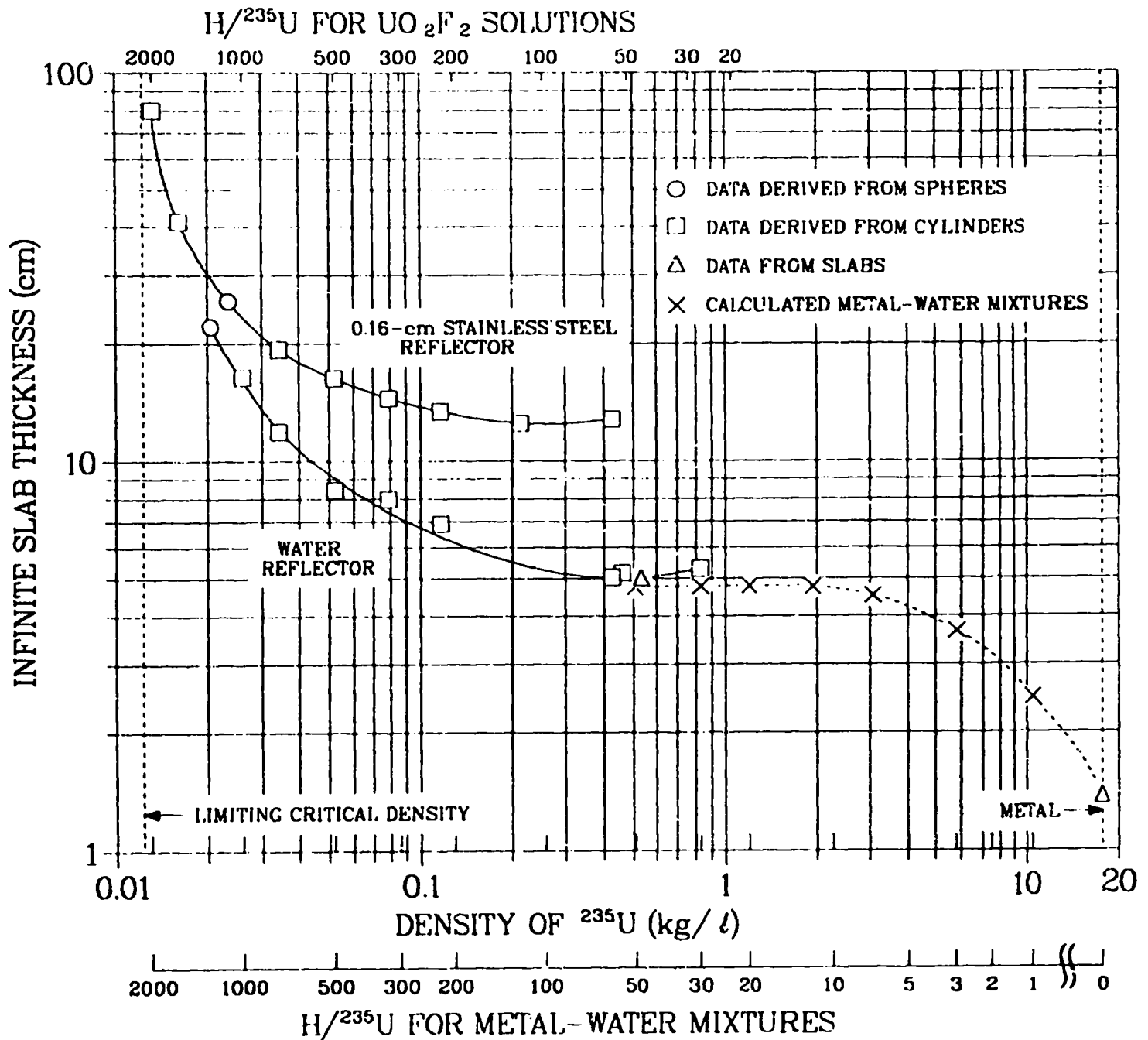

Figure 15. Estimated critical thicknesses of slabs, infinite in other dimensions, of homogeneous water-moderated U(93.2). Solution data appear unless indicated otherwise. Unreflected infinite slabs are fictitious. (From LA-10860-MS, Figure 13).

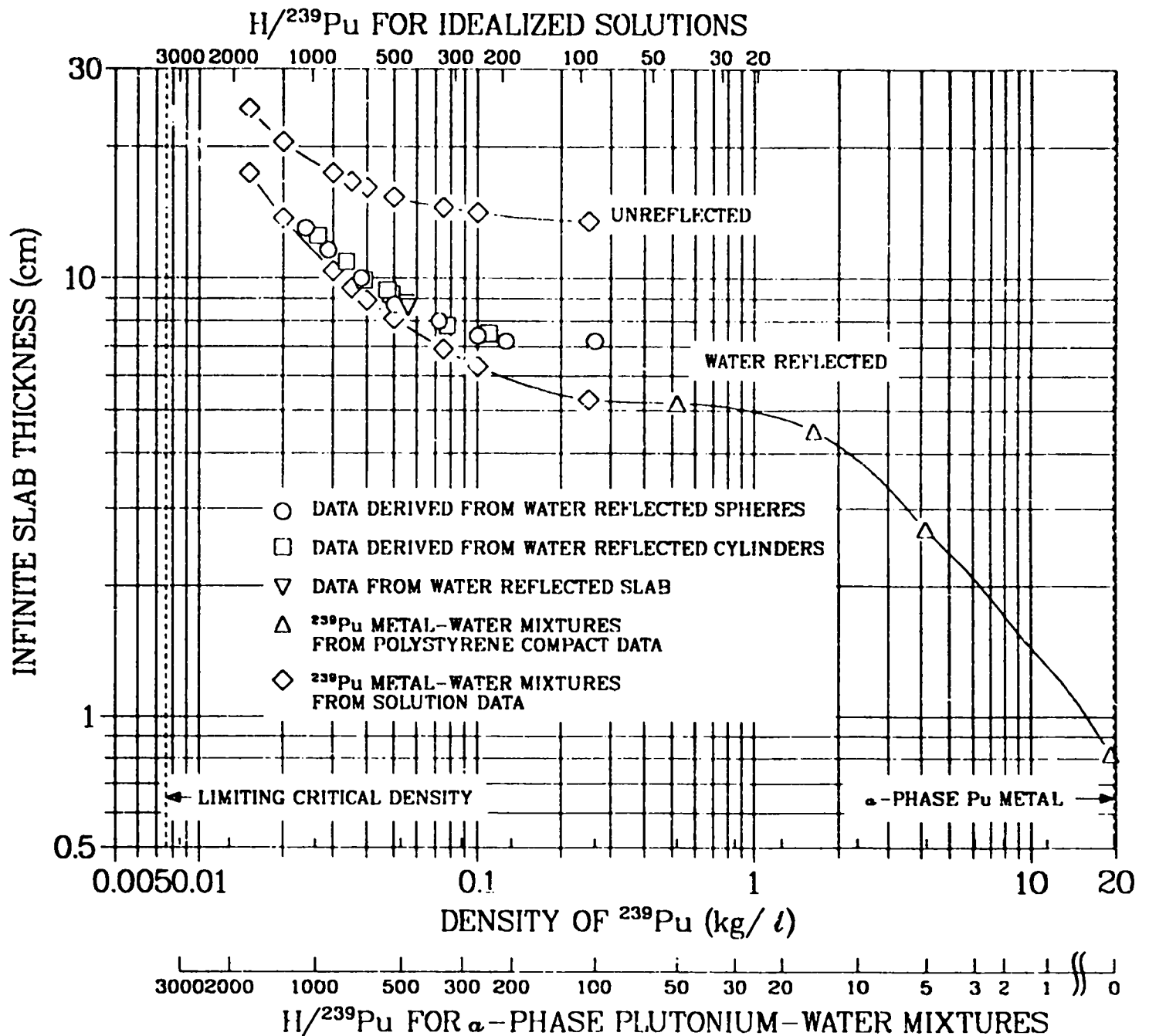

Figure 16. Estimated critical thicknesses of slabs, infinite in other dimensions, of homogeneous water-moderated  $^{239}\text{Pu}$ . Unreflected infinite slabs are fictitious. The points suggesting an intermediate curve apply to water-reflected  $\text{Pu}(\text{NO}_3)_4$  solutions with 1 N  $\text{HNO}_3$  and 3.1%  $^{240}\text{Pu}$  content of the plutonium. (From LA-10860-MS, Figure 34).



### 3. INFLUENCE OF DENSITY ON CRITICALITY

The brief exposition given in this section is largely taken from reference LA-3612, which should be consulted for additional information regarding density effects. In particular, we will limit the discussion to bare, homogenous systems undergoing uniform density changes. For these stipulations, the influence of system density on critical mass is described by perhaps the only law in criticality physics that is simultaneously exact, simple, and useful. This law states "In a critical system, if the densities are increased everywhere to  $x$  times their initial value and all the linear dimensions are reduced to  $1/x$  times their initial value, the system will remain critical."

Thus, to maintain  $k = 1.0$  (critical) in a homogenous sphere, the critical radius must be inversely proportional to the density, or:

$$r_c \propto 1 / \text{density.}$$

Since the critical mass of a system may be written as the product of volume and density, we can obtain the following relationships between the critical mass and density.

For finite geometries (such as spheres, cubes, and cylinders)

$$m_c \propto 1 / (\text{density})^2.$$

For one-dimensional geometries, that is, thin slabs, very long cylinders, and spheres, the following critical mass / density relationships apply: slab — the critical mass per unit area of the slab is proportional to a constant; cylinders — the critical mass per unit length is proportional to one over the density; and, spheres (in fact, any three-dimensional body) — the critical mass is proportional to one over the density squared.

This density law is entirely general and applies to any mixture of materials in any geometrical shape and reflected in any manner, provided only that the entire system undergoes the same, uniform density change.

A few examples of high-leakage storage containers in use at LANL and elsewhere will be given in the section on handling and storage. First, let us consider one other practical means of storing or processing substantial quantities of fissile material in a critically safe manner.

### 4. USE OF NEUTRON ABSORBERS (POISONS) FOR CRITICALITY CONTROL

Without resorting to a high-leakage geometry, it is sometimes practical to maintain a low state of criticality during an operation or for hypothetical upset protection by the use of nonfissioning materials, called poisons, which have very high neutron absorption cross sections. Neutron poisons are most effective for absorbing thermal neutrons; the most common of these are boron, cadmium, and lithium.

Simply, there are no materials that are extremely good absorbers of fast neutrons. By comparison, the absorption cross sections of  $^{235}\text{U}$ ,  $^{239}\text{Pu}$ , boron, cadmium, lithium, hydrogen, and beryllium at 2,000 m/s (0.025 eV) are as follows.

**ABSORPTION CROSS SECTIONS FOR THERMAL NEUTRONS**  
(in barns)

|                  |                   |     |      |    |      |        |
|------------------|-------------------|-----|------|----|------|--------|
| <sup>235</sup> U | <sup>239</sup> Pu | B   | Cd   | Li | H    | Be     |
| 685              | 1020              | 764 | 2520 | 71 | 0.33 | 0.0098 |

---

From this tabulation it is evident that the neutron poisons boron, cadmium, and lithium can compete heavily for the available neutrons. On the other hand, hydrogen and beryllium, which are good moderators, do not compete with fissile isotopes unless the atom ratio of moderating atom density to fissile atom density is very large.

For example, consider a bare, thermal <sup>235</sup>U-H<sub>2</sub>O system which is characterized by the average probabilities:

$$\text{Leakage probability} = 0.75$$

and

$$\text{Absorption probability} = 0.25.$$

Neglecting absorption in the water and assuming a capture to fission ratio of 1 : 4, the state of criticality would be

$$k = 0.25 \times 0.8 \times 2.5 = 0.5.$$

To reduce the state of criticality to a lesser value for routine operations, say ~0.2, one could add, for example, boron to the solution. If it were added in the proportion two boron atoms per atom of <sup>235</sup>U, and assuming the absorption cross sections were equal, then the new multiplication factor would be

$$k = 0.25 \times 0.33 \times 0.8 \times 2.5 = 0.17,$$

where the 0.33 factor is the relative absorption rate in <sup>235</sup>U divided by the total absorption rate.

As a second example of the potential use of neutron poisons, consider a bare fissile system for which it is desired to provide added criticality safety margin in the unlikely event of a flooding accident. Now, a water reflector will return predominantly thermal neutrons to the system; thus, if the bare system were tightly enclosed in a thin (e.g., ~1 mm) cadmium sheet, then less than 1% of the thermal neutrons would be returned in such a flooding accident. This shows how cadmium could be used to partially isolate the system from the consequences of a flooding accident.

## **B. PRACTICAL FISSILE MATERIAL HANDLING AND STORAGE**

The variety of fissile species throughout LANL and their diverse chemical and physical forms probably encompass that found anywhere. Thus, a look at some of the ways by which criticality is controlled in the handling and storage of fissile

materials at LANL will likely be recognized as very similar to controls in effect elsewhere.

Methods of criticality control discussed in this section include limiting volumes and dimensions of containers, limiting masses, and the use of internal neutron absorbers or poisons.

### **1. FIVE-LITER DISSOLUTION POTS**

In the aqueous recovery section of the Los Alamos plutonium facility, the use of 5-liter pots for the dissolution of various plutonium compounds has been standard practice for over 20 years. These vessels are essentially spherical and are wrapped in a heating mantle over their lower portions.

From Figure 12, it is apparent that the minimum critical volumes for bare and thick-water-reflected spheres of plutonium solutions are about 12- and 6-liters, respectively. Also it is obvious that the normal operating conditions for the 5-liter pots is nearly bare (unreflected). Now, while full water reflection may seem incredible, even if this were to occur, the pot would remain slightly subcritical because of its constrained volume.

Thus, due to the relatively high neutron leakage afforded by the diameter of the 5-liter pots, they will remain subcritical at any credible solution concentration, even coincident with extremely unlikely reflection conditions.

Note, however, that while a rich (few hundred grams per liter) solution is essentially ever-safe in a 5-liter pot, if diluted in a larger vessel, criticality could be achieved with that same mass of plutonium.

### **2. CYLINDRICAL STORAGE PROCESS VESSELS AND STORAGE TANKS**

Common to handling and storing of larger volumes of solutions of both plutonium and uranium are the use of cylindrical vessels of 6 inches (15 cm) in diameter. The cylinder lengths will vary depending on capacity requirements since there are about 18 l/m of 6 in. pipe. Once again, the relative ease with which neutrons can leak out of this vessel results in practical, large volume solution storage and handling under conditions whereby subcriticality is controlled by geometry, regardless of solution concentration or vessel length.

Obviously, the 6-in.-diameter vessel is a favorable geometry design regardless of its length, but only in isolation. 6 in., or even 5 in.- or less, diameter tanks can be made critical depending on solution concentration, array size, and tank spacing. However, emptying the contents of a 1-meter-long column (capacity 18 l) into a more compact vessel could lead to a critical system with the same total mass of plutonium or uranium.

### **3. STORAGE IN SLAB TANKS**

The use of thin, flat-faced containers for solution storage has increased at LANL in the few past years. One group has designed, fabricated, and installed one of about 70 l capacity. As it is only 8-cm thick, it is conveniently and unobtrusively mounted above and away from other activities and equipment.

Its location precludes substantial accidental reflection on the broad faces. Also, many transverse through-bolts in conjunction with a pressure relief diaphragm provide confidence that hypothetical overpressurizations will not buckle or bow out a side wall of the tank, which would likely lead to a less-favorable, less-leaky (neutron-wise) geometry and possibly a criticality accident.

While specific, three-dimensional neutronics calculations were performed in the criticality assessment of this slab tank, guidance in this regard is also provided by Figures 15 and 16.

#### **4. VAULT STORAGE OF FISSIONABLE MATERIAL**

While there are numerous fissionable material storage vaults throughout LANL, one of the largest and the one with the most diverse contents is in the basement of the plutonium facility. Here, there are several storage rooms on both sides of a lengthy corridor with plutonium and uranium metals, oxides, compounds, etc., stored in bottles and cans ranging up to large shipping containers.

For each stored unit, criticality safety is ensured by restricting the container volumes or mass of solid material or, frequently, both. An example is metal or oxide storage in (at most) few-liter cans. Large shipping containers always have the active material packaged in inner containers of limited volume.

With the location of many, often diverse fissionable units in one room and many adjoining rooms, there is an added concern, namely that neutronic interaction among the units be controlled. That is, although each individual unit may be small and thus "leaky" as far as neutrons are concerned, if neutrons leaving one unit have a high likelihood of striking and causing fissions in a neighboring container, then it is possible that the entire array or assemblage of units may be capable of becoming critical even though none of the individual units can. This may be likened to fuel rods in a reactor where one or even many are subcritical by themselves, but together they form a critical assembly.

For this reason, not only are maximum floor, shelf, or cubicle loadings prescribed as criticality limits, but also spacing units as far apart as practical is encouraged.

# Factors Affecting Criticality\*

## INTRODUCTION

Operations involving significant quantities of fissile materials may pose the risk of accidental nuclear criticality, which could result in large, prompt-neutron and gamma-ray exposures up to and including lethal doses.

## ACCIDENT HISTORY

Only eight criticality accidents have been reported in the processing of fissile material worldwide since 1944 when sufficient material became available. All eight have involved solutions; none have involved metals or powders. From these eight accidents, two fatalities have resulted, but as long as significant quantities are handled, there will always be the risk of a criticality accident. Operator and first-line supervisor knowledge, awareness, and safety consciousness in following written and approved procedures will always be the mainstay in preserving this excellent record. One of the eight accidents did occur at Los Alamos in a plutonium scrap recovery operation in 1958 and led to the loss of a life from an estimated 12,000-rem exposure. Nearly all of the exposure was received in much less than one second.

There have also been numerous accidents with reactors and critical experiments in both the government and private sectors. Included here are accidents during critical mass measurements (critical experiments), which resulted in lethal radiation overexposures, one in 1945 and one in 1946. It is appropriate to distinguish these reactor accidents from process criticality accidents. Reactor operations intentionally bring fissile material to or near the critical point. These operations at Los Alamos fall under the review of the Laboratory's Reactor Safety Committee. Process operations (including handling, storage, and transportation) for which the intent is to always stay far subcritical, fall under the review of the Laboratory's Nuclear Criticality Safety Committee with technical assistance provided by the Nuclear Criticality Safety Group.

## GUIDING PRINCIPLES

Criticality safety, as with all areas of safety, is a line management responsibility. At Los Alamos, the nuclear criticality safety staff and Nuclear Criticality Safety Committee assist line management by providing technical guidance and review. Two statements of nuclear criticality safety practices summarize principles embodied in this technical support.

"Before a new operation with fissionable material is begun or before an existing operation is changed, it shall be determined that the entire process will be subcritical under both normal and credible abnormal conditions."<sup>1</sup>

---

From Los Alamos National Laboratory Health and Safety Manual, Technical Bulletin 401, "Nuclear Criticality Safety," October 1990.

"Process designs should, in general, incorporate sufficient factors of safety to require at least two unlikely, independent, and concurrent changes in process conditions before a criticality accident is possible."<sup>2</sup>

These quotes are from the general consensus standard, ANSI/ANS-8.1-1983 (R1988), "Nuclear Criticality Safety in Operations with Fissionable Material Outside Reactors." The reference section of this bulletin lists many other pertinent documents.

Nuclear criticality safety is concerned with the prevention of an accidental critical or supercritical chain reaction during the processing, handling, and storage of fissile materials.

It is necessary to control certain factors that affect the safety of any system containing fissile materials. By maintaining proper control of these factors, operations can be kept safe.

The following ten factors influence the criticality aspects of fissile material operations. Since the relative contribution of these factors will be process dependent, the setting of process limits that appropriately control criticality risks is as much an art as a science and requires substantial communication between criticality safety staff and process supervision.

## **MASS**

Before a criticality accident can occur, a certain amount of fissile material must be present. This amount of fissile material necessary to cause a criticality is called the minimum *critical mass*. If the amount of fissile material being processed, handled, or stored is always less than the minimum critical mass, then neutrons will escape out of the material before a self-sustaining chain reaction can be started. The less fissile material being handled, the less chance of having a criticality accident. The minimum masses of two particular fissile isotopes to attain a critical state are 500-grams <sup>239</sup>Pu and 800-grams <sup>235</sup>U.

## **VOLUME**

Particularly for solutions and loose powders that could accidentally become flooded, container volumes less than 6 liters are often used as an aid to criticality control.

## **SHAPE**

Shape is an important consideration in nuclear criticality safety. To maintain safety margins, which are not solely dependent on fissile mass or neutron poisons, it is necessary to have a shape that will allow neutrons to escape or leak out. The "leakiest" shapes will have a large surface area for a given volume; thin slabs and small diameter cylinders are favorable shapes for enhancing neutron leakage. The least "leaky" shape is a sphere. It has the smallest surface area for its volume. A neutron generated inside a sphere has a better chance of causing a fission before it escapes into the surrounding environment than a neutron born in the same volume slab tank or cylindrical vessel.

The farther a neutron has to travel through the fissile material before it can escape, the more likely it is that the neutron will collide with a fissile nucleus. Long paths mean a high likelihood of fission; short paths mean a smaller likelihood of fission.

## DENSITY

This parameter is a measure of the spacing between atoms in *dry* metals and powders. When used to describe fissile material, it means how tightly the fissile atoms are packed together. A high density means that there are more atoms present, making it harder for a neutron to escape from the material without colliding with a fissile atom and possibly causing a fission. Obviously, the greater the spacing (and therefore the lower density), the greater the neutron leakage will be.

## CONCENTRATION

Concentration is similar to density, but is often used to describe how much fissile material is present in a volume of solution. In solutions, the concentration of fissile material has a large impact on the critical mass and critical volume. For example, the minimum critical masses of  $^{235}\text{U}$  and  $^{239}\text{Pu}$  are about 800- and 500-grams, respectively, at solution concentrations of 30- to 40-g/l. Below 5 g/l, infinite volumes cannot be made critical.

## REFLECTION

Reflection is the "bouncing" back of neutrons into a fissile material region because of collisions with atoms in surrounding materials. Neutrons are bounced back into a fissile material region by "reflectors."

The reflection of neutrons back into a fissile region is the opposite effect we would like to have. If neutrons leak out of a system and are not reflected back into it, those that leak out cannot affect the system. But when neutrons are reflected back, we lose the margin of safety that leakage provided us.

For example, a thin layer of cutting fluid on a fissile part being machined represents almost no reflection. Immersing that same part in a bucket of water, such that there are a few inches of water surrounding it, could reduce the amount of fissile material required for a critical mass by about a factor of two.

## ENRICHMENT

This terminology refers to the percentage of fissile atoms in a given amount of material. For uranium, the convention is to express the enrichment in terms of the fissile ( $^{235}\text{U}$ ) content, U(93), for example. This means that for every 100 grams of uranium, 93 grams are composed of  $^{235}\text{U}$  atoms and the remaining 7 are composed of  $^{238}\text{U}$  atoms. For plutonium, the convention is the opposite; the enrichment is the nonfissile ( $^{240}\text{Pu}$ ) content. Most plutonium is about 94%  $^{239}\text{Pu}$  and 6%  $^{240}\text{Pu}$ . When more atoms of a fissile species are present, neutrons are more likely to hit a fissile atom and cause fissions.

## INTERACTION

Interaction among accumulations of fissile material occurs when neutrons from one container reach and penetrate others. Interaction between two or more containers of fissile material reduces the net leakage of neutrons from each container.

Therefore, as two subcritical systems are brought closer to each other, the index of criticality, i.e., the multiplication factor, for the interacting system will be greater than if the units were isolated since each gains neutrons from the other.

Containers/accumulations/pieces of fissile material are kept far enough apart so that there will be a minimum of interaction of neutrons, either during processing or during storage.

A large amount of water or other good moderating and absorbing material between separated masses of fissile material reduces neutron interaction.

## MODERATION

Neutrons that are emitted as a result of fission are "born" at very high speeds or energies. Moderation means the slowing down of these neutrons from very high speeds to relatively low speeds. The nucleus of a fissile atom can capture a slow neutron more readily than it can a fast one.

If a fast neutron hits a heavy nucleus, such as  $^{235}\text{U}$  or  $^{239}\text{Pu}$ , and if it is not absorbed, it will bounce off without losing speed; but if a neutron hits a small, light-weight nucleus of about its own size (such as hydrogen, deuterium, carbon), it can lose some or most of its speed to the small nucleus. Hence, light elements are far more effective moderators than heavy ones.

If materials that moderate neutrons are added to a system, less fissile material may be required for the system to reach the critical state. For example, 500 to 800 grams of  $^{239}\text{Pu}/^{235}\text{U}$ , respectively, are the minimum critical masses in solution, while 6,000 to 25,000 grams are the minimum metal critical masses for the same isotopes.

Hence, safety margins for fissile materials are greater if moderation is minimized or avoided. If the presence of a good moderator, such as water, is unavoidable, other controls, such as greater separation or dilution, must be introduced to reduce the possibility of a criticality accident.

## POISONS

Poisons refer to materials that play a dominant role in absorbing neutrons, but do not fission or give off more neutrons.

Boron, cadmium, and gadolinium are examples. Poisons are most commonly used in solution processing such as borosilicate glass Raschig rings in large process vessels or boron-epoxy loaded stirrer rods in precipitation vessels of unfavorable geometry.

## REFERENCES

1. Extracted from American National Standard ANSI/ANS-8.1-1983 (R1988), "Nuclear Criticality Safety in Operations With Fissionable Materials Outside Reactors," with permission from the publisher, the American Nuclear Society.
2. Extracted from the American National Standard ANSI/ANS-8.19-1984 (R1989), "Administrative Practices for Nuclear Criticality Safety," with permission from the publisher, the American Nuclear Society.



For technical and administrative guidance, the documents listed below are quite complete.

1. ANSI/ANS-8.1-1983 (R1988), "Nuclear Criticality Safety in Operations With Fissionable Materials Outside Reactors."
  2. ANSI/ANS-8.3-1986 (Rev.), "Criticality Accident Alarm System."
  3. ANSI/ANS-8.5-1986 (Rev.), "Use of Borosilicate-Glass Raschig Rings As A Neutron Absorber In Solutions Of Fissile Material."
  4. ANSI/ANS-8.6-1983 (R1988), "Safety In Conducting Subcritical Neutron-Multiplication Measurements *In Situ*."
  5. ANSI/ANS-8.7-1975 (R1987), "Guide for Nuclear Criticality Safety in the Storage of Fissile Materials."
  6. ANSI/ANS-8.9-1987 (Rev.), "Nuclear Criticality Safety Criteria For Steel-Pipe Intersections Containing Aqueous Solutions Of Fissile Material."
  7. ANSI/ANS-8.10-1983 (R1988), "Criteria For Nuclear Criticality Safety Controls In Operations With Shielding And Confinement."
  8. ANSI/ANS-8.12-1987 (Rev.), "Nuclear Criticality Control And Safety Of Plutonium-Uranium Fuel Mixtures Outside Reactors."
  9. ANSI/ANS-8.15-1987 (Rev.), "Nuclear Criticality Control of Special Actinide Elements."
  10. ANSI/ANS-8.17-1989 (Rev.), "Criticality Safety Criteria For The Handling, Storage, And Transportation Of LWR Fuel Outside Reactors."
  11. ANSI/ANS-8.19-1984(R1989), "Administrative Practices For Nuclear Criticality Safety."
  12. ANSI/ANS-8.20-1991, "Nuclear Criticality Safety Training."
- The above documents are published by and are available from The American Nuclear Society.
13. H. C. Faxton and N. L. Pruvost, "Critical Dimensions of Systems Containing  $^{235}\text{U}$ ,  $^{239}\text{Pu}$ , and  $^{233}\text{U}$ ," Los Alamos National Laboratory, LA-10860-MS, 1986 Revision.
  14. NUREG Committee, "Nuclear Safety Guide," Edited by J. T. Thomas, Union Carbide Corporation, TID-7016, Revision 2, 1978.
  15. D. R. Smith, "A Review of Criticality Accidents," DOE/NCT-04, Nuclear Criticality Information System, March 1989.
  16. H. C. Paxton, "Criticality Control in Operations with Fissile Material," Los Alamos National Laboratory, LA-3366, 1964.
  17. DOE Order 5480.5, "Safety of Nuclear Facilities," September 1986.

- 18. M.J. Vehec, "Principles of Nuclear Safety," Westinghouse Materials Company of Ohio, 1987.**
- 19. "Nuclear Safety," E. I. duPont de Nemours and Company, Savannah River Laboratory, 1971.**
- 20. "Principles of Nuclear Safety," Oak Ridge Y-12 Plant, Union Carbide Corporation, 1972.**
- 21. L.L. Lowery, "Nuclear Criticality Safety," Lawrence Livermore National Laboratory, 1986.**
- 22. "Nuclear Criticality Safety," Technical Bulletin 401 of the Environment, Safety and Health Manual, Los Alamos National Laboratory, 1990.**

# Critical Dimensions of Systems Containing $^{235}\text{U}$ , $^{239}\text{Pu}$ , and $^{233}\text{U}$ \*

H. C. Paxton and N. L. Pruvost

## RELATIONS FOR CONVERSION TO STANDARD CONDITIONS

Many of the data correlations that appear in this report required the conversion of experimental information to certain "standard" conditions. Two of the most significant types, shape and density conversions, are considered immediately. Other types, such as the correction for variations in  $^{235}\text{U}$  enrichment, fit more naturally into later sections.

### CYLINDER - SPHERE CONVERSIONS

Ratios of critical masses of cylinders (height  $h$  and diameter  $d$  to those of spheres appear versus  $h/d$  in Figure 4 for enriched uranium solutions (aqueous solutions are implied throughout this document) and in Figure 5 for enriched uranium metal. The values for solutions and U(93) metal reflected by polyethylene and Plexiglas<sup>®</sup> are derived from measurements at Oak Ridge.<sup>32,36</sup> Those for U(94) metal, unreflected and reflected by paraffin or water, are from Los Alamos.<sup>37,39</sup> Early critical data for plutonium solutions originated at Hanford<sup>26</sup> and for  $^{233}\text{U}$  solutions at Oak Ridge.<sup>40</sup>

For extrapolation of experimental critical dimensions to those of broad slabs and long cylinders, the following method is used. The dimensions of critical cylinders of different sizes and of a critical sphere, all of the same composition, are related to each other through the expression for geometric buckling,  $B^2$ , provided appropriate value of the cylinder extrapolation distances are used. Effective values of cylinder extrapolation distances were obtained from the following relationship using cylinder and sphere dimensions and sphere extrapolation distances of Table 5.

$$B^2 = \frac{2.405^2}{(r_c + \delta_c)^2} + \frac{\pi^2}{(h + 2\delta_c)^2} = \frac{\pi^2}{(r_s + \delta_s)^2}$$

where  $r_c$  = the radius of the cylinder  
 $h$  = the height of the cylinder  
 $r_s$  = the radius of the sphere  
 $\delta$  = the effective extrapolation distance appropriate to these dimensions

---

\* From Los Alamos National Laboratory report LA-10860-MS (rev. 1986).

Table 5. Sphere Extrapolation Distances for General Application of Figure 6  
Water Reflection

|                               | Sphere Extrapolation Distance $\delta_s$ (cm) |            |            |             |
|-------------------------------|---|------------|------------|-------------|
|                               | Atomic Ratio H/X*: <u>50</u>                  | <u>200</u> | <u>500</u> | <u>1000</u> |
| $^{235}\text{UO}_2\text{F}_2$ | 5.8   | 5.4        | 5.2        | 5.2         |
| $^{233}\text{UO}_2\text{F}_2$ | 5.6   | 5.2        | 5.0        | 5.0         |
| $\text{Pu}(\text{NO}_3)_4$    | 6.3   | 5.8        | 5.4        | 5.2         |

\*X  $\equiv$   $^{235}\text{U}$ ,  $^{233}\text{U}$ , or Pu.

The resulting ratios of cylinder to sphere extrapolation distances appear in Figure 6, in which some dimensions were obtained experimentally and some were computed by TWODANT<sup>13</sup> with Hansen-Roach cross sections.<sup>10</sup> Figure 7 gives similar extrapolation distances for reflected and unreflected U(93.5) metal disks, where  $\delta_s = 2.0$  cm is assumed for an unreflected sphere and reflector savings are consistent with Figure 5.

In Figures 6 and 7, the abscissa was chosen such that at zero, the value of  $\delta_s$  determines the thickness of an infinite slab [ $t = (\pi/B) - 2\delta_s$ ] and at unity the value determines the radius of an infinite cylinder [ $r = (2.405/B) - \delta_s$ ]. The calculated end points of Figure 6 were obtained by means of the ONEDANT<sup>11,12</sup> code and Hansen-Roach cross sections.<sup>10</sup> In Table 5, the value of the sphere extrapolation distance for  $^{235}\text{UO}_2\text{F}_2$  solution at  $H/^{235}\text{U} = 50$  was obtained from Stratton's report, LA-3612<sup>14</sup>, by combining the extrapolation distance without reflector from his Equation 2 and the reflector savings from Table V. Results are  $\delta_s = 5.8$  cm with a water reflector and  $\delta_s = 2.2$  cm with a 0.13-cm-thick stainless steel reflector. Other extrapolation distances in Table 5 (for more dilute  $^{235}\text{U}$ ,  $^{233}\text{U}$ , and Pu solutions) were obtained from sphere, infinite cylinder, and infinite slab dimensions required to bring both calculated end point extrapolation distances into coincidence with the end points of Figure 6.

With 0.13-cm stainless steel reflection,  $\delta_s = 2.2$  cm from Stratton's spheres applies universally to the transformation of solution cylinders. It has been confirmed empirically within  $\pm 2\%$  for  $(\text{U93.2})\text{O}_2\text{F}_2$ ,  $^{233}\text{UO}_2\text{F}_2$ , and  $\text{Pu}(\text{NO}_3)_4 + 1\text{N HNO}_3$  solutions over the experimentally available ranges of height-to-diameter ratios.

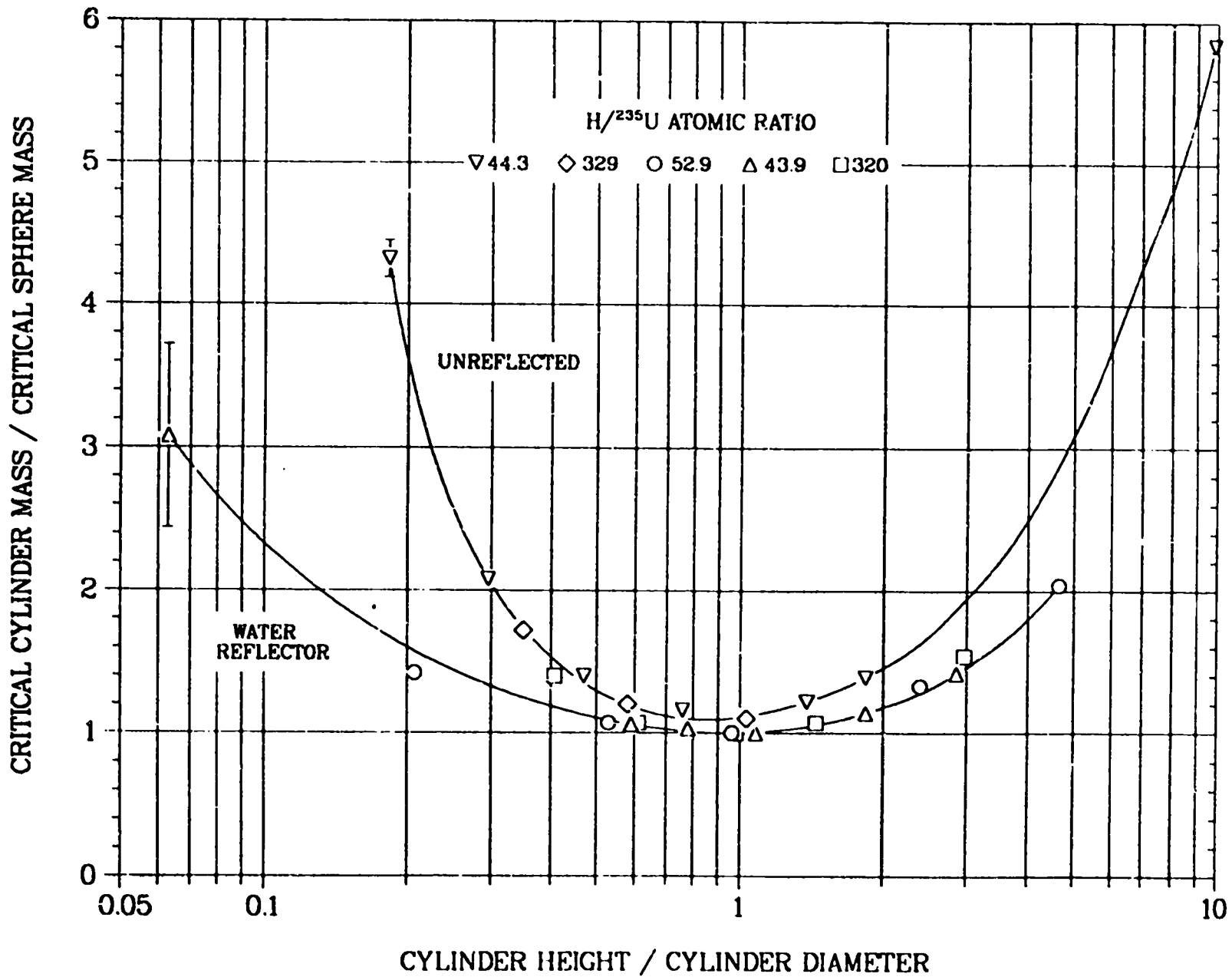

Figure 4. The ratio of cylindrical to spherical masses of U(93)O<sub>2</sub>F<sub>2</sub> solutions, unreflected and with water reflector, as a function of cylinder height to cylinder diameter ratio.

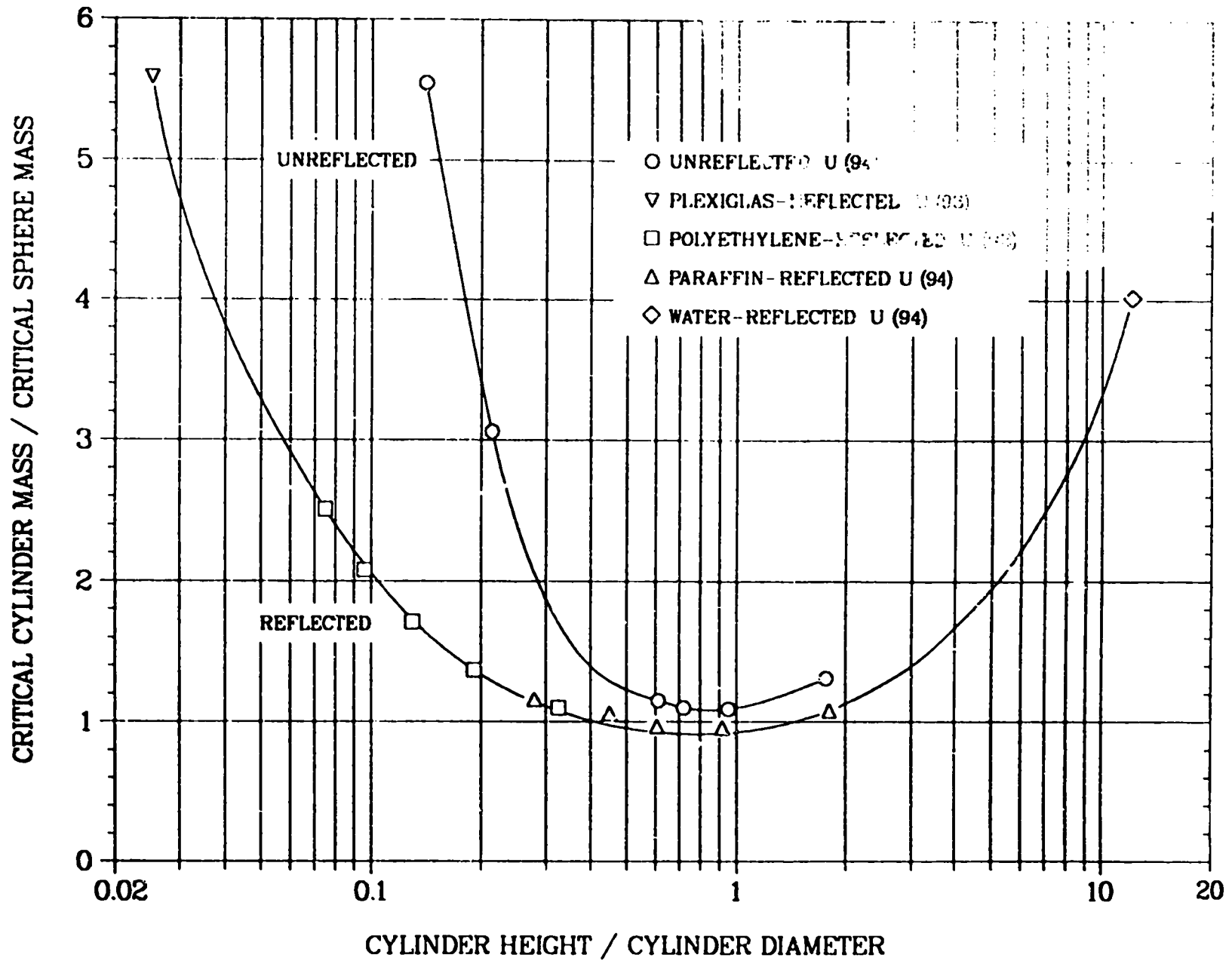

Figure 5. The ratio of cylindrical to spherical masses for U(>90) metal, unreflected and with hydrogenous reflector, as a function of cylinder height to cylinder diameter ratio.

## CORE-DENSITY CONVERSIONS

A change in the density of a fissile sphere by the ratio  $\rho/\rho_0$  leads to a changed critical mass,  $m_c$ , that may be expressed as

$$m_c / m_{c0} = (\rho / \rho_0)^n$$

where  $n$  is constant over a considerable range of density ratios. In fact, where density of both spherical core and reflector is changed by the same ratio and the ratio of reflector thickness to core radius is maintained, then  $n = 2$  (the value for an unreflected sphere). Similarly, in the case of an infinite slab, the critical mass per unit area is necessarily independent of  $\delta$  (i.e.,  $n=0$ ).

Where reflector characteristics remain constant, however, the value of  $n$  associated with the density change of a spherical core depends considerably upon the system. Combined Los Alamos, Livermore, and Rocky Flats data for U(93.5) metal and  $\delta$ -phase plutonium cores<sup>20,41,42</sup> seem to follow a unique relation between the density exponent and the degree of reflection (see Figure 8). The scatter associated with plutonium measurements would mask any small differences between the two fissile materials.

The experimental values of  $n$  (as determined by the UKAEA Atomic Weapons Research Establishment at Aldermaston, ORNL, and Los Alamos) for near-equilateral nonmetal cores are given in Table 6.<sup>43,46</sup>

Table 6. Experimental Values of the Negative Density Exponent,  $n$ , for Nonmetal Cores.

| Core  |                     | Reflector                  | $n$               | Ref. |
|---|---------------------|----------------------------|-------------------|------|
| Composition   | H/ <sup>235</sup> U |                            |                   |      |
| U(30)O <sub>2</sub> -paraffin                       | 8.26                | 20.3-cm-thick Perspex*     | 1.46              | 43   |
| U(30)O <sub>2</sub> -paraffin                       | 16.5                | 20.3-cm-thick Perspex      | 1.50              | 43   |
| U(30)O <sub>2</sub> -paraffin                       | 82.0                | 20.3-cm-thick Polyethylene | 1.69              | 43   |
| U(30)O <sub>2</sub> -paraffin                       | 82.0                | 20.3-cm-thick Perspex      | 1.56              | 43   |
| U(30)O <sub>2</sub> -paraffin                       | 82.0                | 20.3-cm-thick Polyethylene | 1.67              | 43   |
| U(30)O <sub>2</sub> -paraffin                       | 82.0                | thick water                | 1.65              | 43   |
| U(93)O <sub>2</sub> (NO <sub>3</sub> ) <sub>4</sub> | 230.0               | thick water                | 1.88 <sup>b</sup> | 44   |
| U(93)H <sub>3</sub> C                               | 3.2                 | 22.2-cm-thick U(0.7)       | 1.57              | 45   |

\*Methacrylate plastic, called Plexiglas in the U.S.

<sup>b</sup>Possibly influenced by the manner in which voids were introduced.

The lack of experimental core-density exponents for solutions, forces the use of computed values. Figure 9 shows such exponents for <sup>235</sup>U calculated by the DSN<sup>11</sup> code using Hansen-Roach cross sections.<sup>10</sup> Hanford calculations for <sup>239</sup>Pu used a similar code (DTK) but different cross sections (from GAMTEC-II).<sup>46</sup>

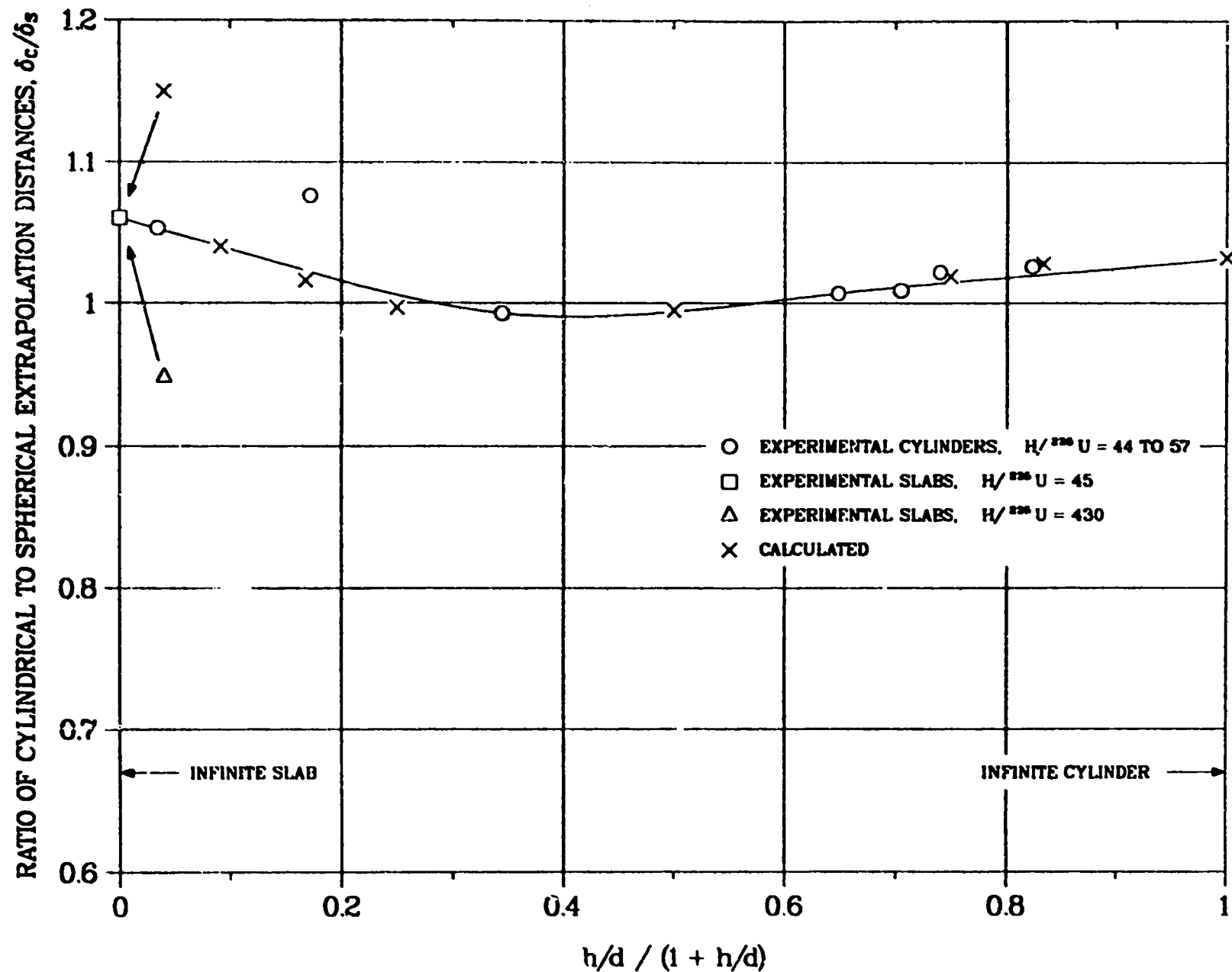
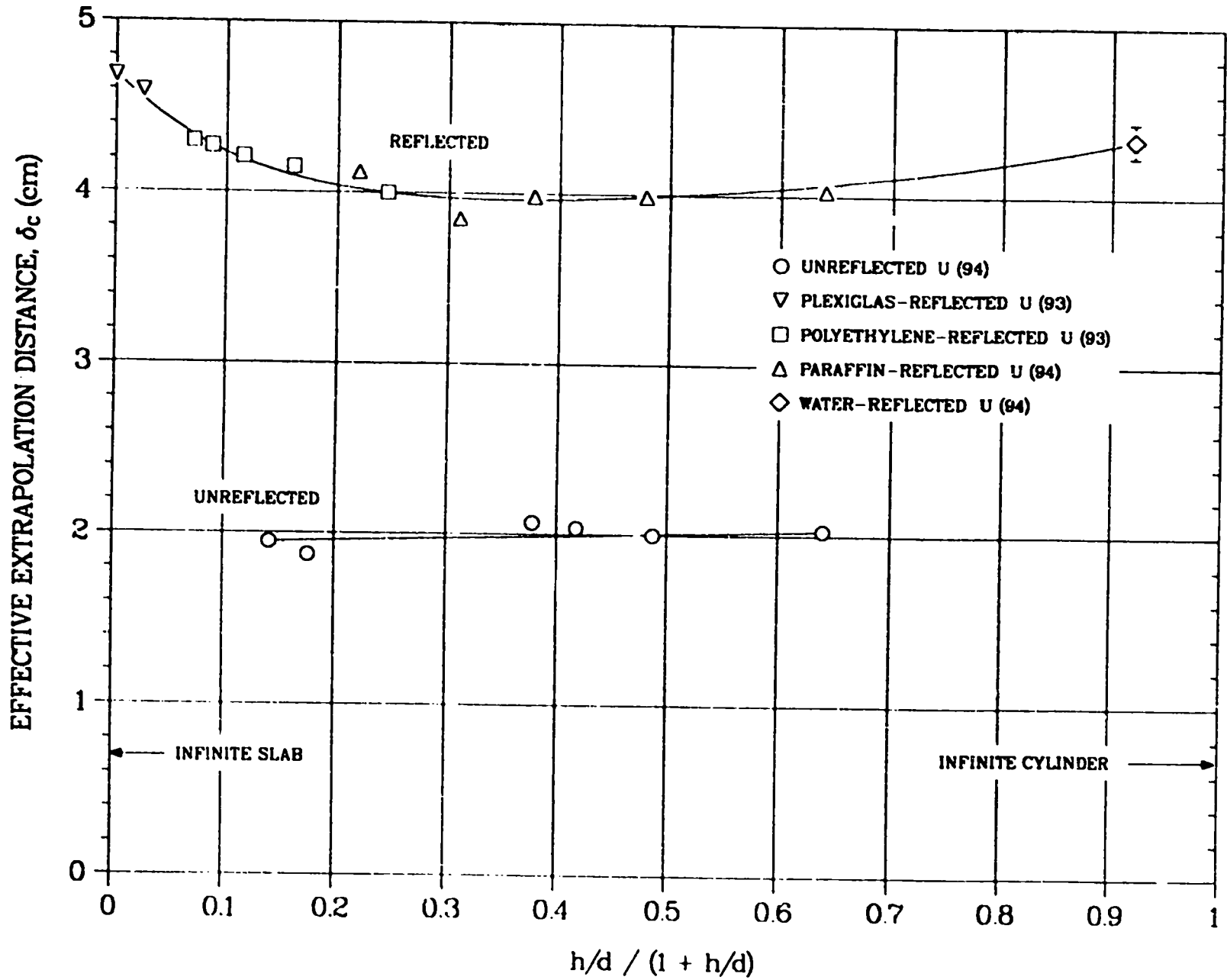

Figure 6. Ratio of extrapolation distance to that of sphere to water-reflected  $\text{U}(93)\text{O}_{22}\text{F}_4$  solutions. Cylinder height and diameter are  $h$  and  $d$ , respectively.





**Figure 7. Effective extrapolation distances of U(>90) metal cylinders, unreflected and with hydrogenous reflectors. Cylinder height and diameter are h and d, respectively.**

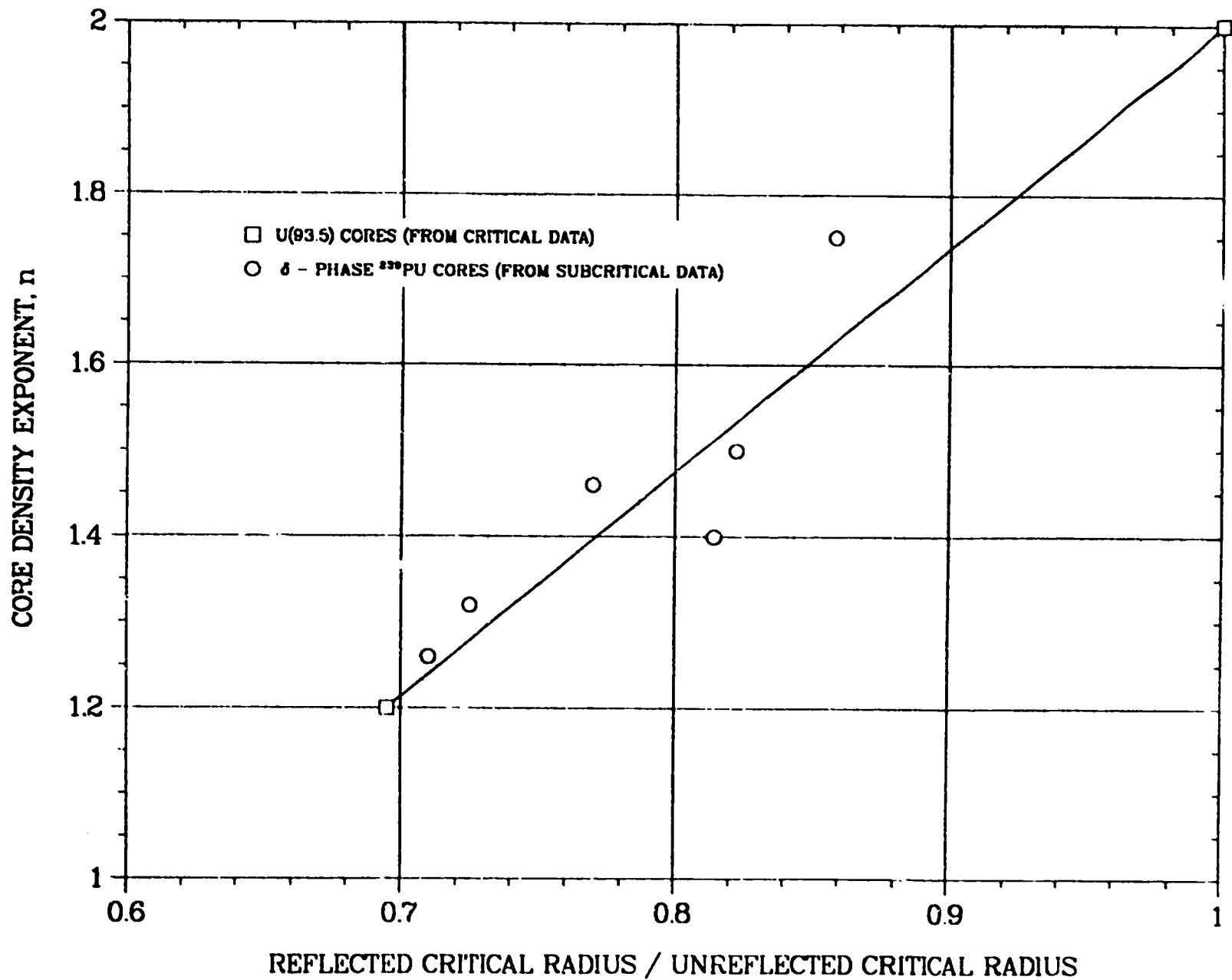
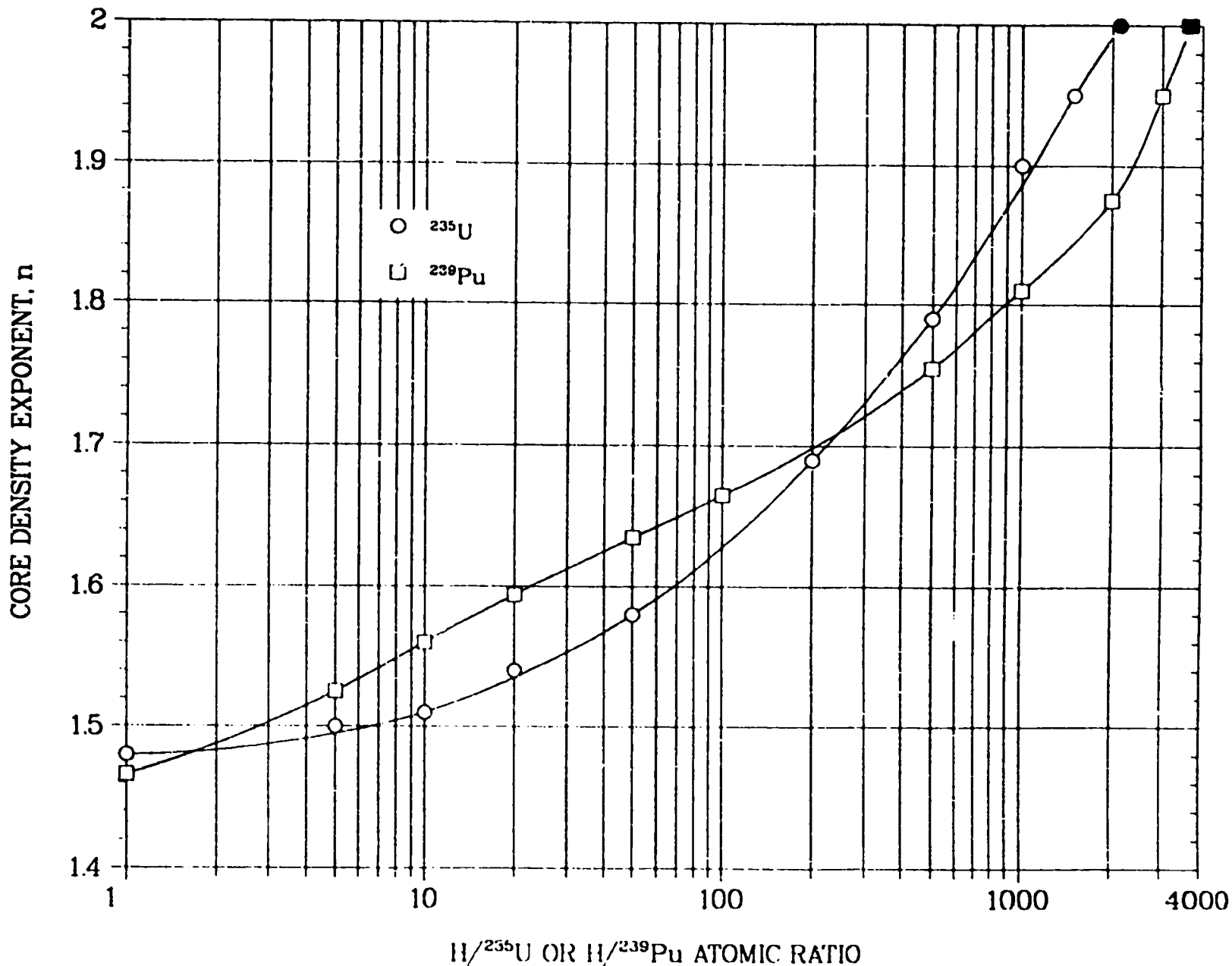

Figure 8. Density exponents of unmoderated spherical cores in constant-density reflectors. Critical mass equals a constant (core density)\*.



**Figure 9. Calculated core-density exponents for water-reflected spheres of homogeneous metal-water mixtures. The solid symbols represent limiting conditions.**

## References

10. G. E. Hansen and W. H. Roach, "Six and Sixteen Group Cross Sections for Fast and Intermediate Critical Assemblies," Los Alamos Scientific Laboratory report LAMS-2543 (September 1961).
11. B. G. Carlson, C. Lee, and W. Worlton, "The DSN and TDC Neutron Transport Codes," Los Alamos Scientific Laboratory reports LAMS-2346 and LAMS-2346, Appendix I (October 1959).
12. R. D. O'Dell, F. W. Brinkley, Jr., and D. R. Marr, "User's Manual for ONEDANT: A Code Package for One-Dimensional, Diffusion-Accelerated, Neutral-Particle Transport," Los Alamos National Laboratory report LA-9184-M (February 1982).
13. R. E. Alcouffe, F. W. Brinkley, D. R. Marr, and R. D. O'Dell, "User's Guide for TWODANT: A Code Package for Two-Dimensional, Diffusion-Accelerated, Neutral-Particle Transport," Los Alamos National Laboratory report LA-10049-M, Rev. 1 (October 1984).
14. W. R. Stratton, "Criticality Data and Factors Affecting Criticality of Single Homogeneous Units," Los Alamos Scientific Laboratory report LA-3612 (September 1967).
20. H. C. Paxton, "Los Alamos Critical Mass Data," Los Alamos Scientific Laboratory report LA-3067-MS, Rev. (December 1975).
26. F. E. Kruesi, J. O. Erkman, and D. D. Lanning, "Critical Mass Studies of Plutonium Solutions," Hanford Atomic Products Operation report HW-24514 (Del.) (May 1952).
32. C. K. Beck, A. D. Callihan, J. W. Morfitt, and R. L. Murray, "Critical Mass Studies, Part III," Carbide and Chemicals Corporation report K-343 (April 1949).
33. J. K. Fox, L. W. Gilley, and A. D. Callihan, "Critical Mass Studies, Part VI. Aqueous  $U^{235}$  Solutions," Oak Ridge National Laboratory report ORNL-2367 (March 1958).
34. J. K. Fox, L. W. Gilley, and J. H. Marble, "Critical Parameters of a Proton-Moderated and Proton-Reflected Slab of  $U^{235}$ ," *Nucl. Sci. Eng.*, **3**, 694-697 (1958).
35. J. T. Mihalczo and J. J. Lynn, "Neutron Multiplication Experiments with Enriched Uranium Metal in Slab Geometry," Oak Ridge National Laboratory report ORNL-CF-61-4-33 (April 1961).
36. J. T. Mihalczo, "Graphite and Polyethylene Reflected Uranium Metal Cylinders and Annuli," Union Carbide Corporation, Nuclear Division report Y-DR-81 (April 1972).
37. G. E. Hansen, H. C. Paxton, and D. P. Wood, "Critical Plutonium and Enriched Uranium-Metal Cylinders of Extreme Shape," *Nucl. Sci. Eng.*, **8**, 570-577 (1960).

38. E. C. Mallery, "Oralloy Cylindrical Shape Factor and Critical Mass Measurements in Graphite, Paraffin, and Water Tamperers," Los Alamos Scientific Laboratory report LA-1305 (October 1951).
39. G. E. Hansen, D. P. Wood, and B. Pena, "Reflector Savings of Moderating Materials on Large-Diameter U(93.2) Slabs," Los Alamos Scientific Laboratory report LAMS-2744 (October 1962).
40. J. K. Fox, L. W. Gilley, and E. R. Rohrer, "Critical Mass Studies, Part VIII. Aqueous Solutions of U<sup>233</sup>," Oak Ridge National Laboratory report ORNL-2143 (September 1959).
41. F. A. Kloverstrom, "Spherical and Cylindrical Plutonium Critical Masses," University of California Radiation Laboratory report UCRL-4957 (September 1957).
42. C. L. Schuske, M. G. Arthur, and D. F. Smith, "Criticality Measurements on Plutonium Metal Preliminary to the Design of a Melting Crucible," Dow Chemical Company, Rocky Flats Plant report RFP-63 (June 1962).
43. R. C. Lane, "Measurements of the Critical Parameters of Under-Moderated Uranium-Hydrogen Mixtures at Intermediate Enrichments," in *Proceeding of the Symposium Criticality Control of Fissile Materials*, Stockholm, 1-5 November 1965 (International Atomic Energy Agency, Vienna, 1966) pp. 177-191.
44. A. D. Callihan, D. F. Cronin, J. K. Fox, and J. W. Morfitt, "Critical Mass Studies, Part V," Carbide and Carbon Chemicals Corporation, K-25 Plant report K-643 (June 1950).
45. G. A. Linenberger, J. D. Orndoff, and H. C. Paxton, "Enriched-Uranium Hydride Critical Assemblies," *Nucl. Sci. Eng.*, **7**, 44-57 (1960).
46. L. E. Hansen and E. D. Clayton, "Criticality of Plutonium Compounds in the Under-Moderated Range, H:Pu  $\leq$  20," *Nucl. Appl.*, **3**, 481-487 (1967).

## BUCKLING CONVERSION EXAMPLE

Situation:

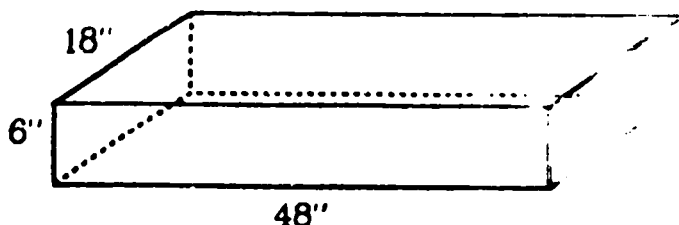

Hand calculations are to be performed to analyze the use of a 3" x 18" x 6" well. The calculations will show whether or not this well may be used safely in a nuclear material environment.

Volume = 3 ft<sup>3</sup> = 85 liters (l); Mass <sup>239</sup>Pu = 2550 grams (g); Concentration at full depth = 30 grams per liter (g/l).

From LA-10860-MS (at 30-g/l):

|         |                                      | Reflector | Bare |
|---------|--------------------------------------|-----------|------|
| Fig. 31 | Critical mass, g                     | 500       | 400  |
| Fig. 32 | Critical volume of sphere, l         | 18        | 31   |
| Fig. 34 | Critical infinite slab thickness, cm | 10        | 17   |

Thus, we have both masses and volumes in excess of that which can be made critical, either bare or reflected, but Fig. 34 tells us that we will not go critical at 30-g/l as a bare parallelepiped (when we factor in <sup>239</sup>Pu and <sup>235</sup>U).

Now let us examine the reflected, full well for criticality using buckling conversions, which in essence is comparing leakage of neutrons from different shapes.

From Table 5 and Figure 6, of this section, an estimate of  $\delta_e$ , the effective extrapolation distance, is 5.1-cm (2.0 inches), and permits a calculation of  $B_w^2$  for the well according to:

$$B_w^2 = \left[ \frac{\pi^2}{(l + 2\delta)^2} \right] + \left[ \frac{\pi^2}{(w + 2\delta)^2} \right] + \left[ \frac{\pi^2}{(h + 2\delta)^2} \right]$$

$$B_w^2 = \left[ \frac{\pi}{48 + 2(2.0)} \right]^2 + \left[ \frac{\pi}{18 + 2(2.0)} \right]^2 + \left[ \frac{\pi}{6 + 2(2.0)} \right]^2$$

$$B_w^2 = \pi^2 \left[ \frac{1}{2704} + \frac{1}{484} + \frac{1}{100} \right] = \pi^2 (0.0124 \text{ in}^{-2})$$

Now, the sphere with an equivalent neutron leakage, i.e., k-value, would be:

$$B_w^2 = B_c^2 = \frac{\pi^2}{(r_c + \delta_c)^2} = \pi^2 (0.0124 \text{ in}^{-2})$$

Estimating  $\delta_c$  as 5.0-cm (2.0-in), we have:

$$(r_c + 2.0)^2 = \frac{1}{0.0124} \quad \text{or}$$

$$r_c = 6.98 \text{ cm} \quad (17.73\text{-cm}) \quad \text{and} \quad V_c \approx 23\text{-l}$$

Thus, the completely flooded and reflected well, at a uniform concentration of 30-g  $^{239}\text{Pu/l}$  and neglecting  $\text{NO}_3$  and absorption by other possible contaminants, would be supercritical since the 23-l volume is larger than the spherical 18-l critical volume.

Variations:

1) What would the reflected critical depth be at 30-g/l?

The reflected critical spherical volume = 18-l.

$$r_c = \left[ \frac{3}{4\pi} 18000 \right]^{1/3} = 6.4 \text{ in (16.3 cm)}$$

$$B_c^2 = \left[ \frac{\pi}{6.4 + 2.0} \right]^2 = \pi^2 \frac{1}{71}$$

$$B_w^2 = \pi^2 \left[ \frac{1}{2704} + \frac{1}{484} + \frac{1}{(h+4)^2} \right] = \pi^2 \frac{1}{71}$$

$$\left[ \frac{1}{h+4} \right]^2 = 0.0116; \quad h = 5.26\text{-inches (13.4-cm)}$$

2) Can the well be made critical at 20-g/l? From LA-10860-MS (at 20-g/l):

|         |                                      | Reflected | Bare |
|---------|--------------------------------------|-----------|------|
| Fig. 31 | Critical mass, g                     | 600       | 1000 |
| Fig. 32 | Critical volume of sphere, l         | 30        | 50   |
| Fig. 34 | Critical infinite slab thickness, cm | 13        | 20   |

An infinite slab could be made critical at 20-g/l and 6-inch depth with modest reflection. The given finite slab (48" x 18" x 6" parallelepiped) is equivalent to a 23-l sphere, has a volume less than the reflected critical volume of 30-l, and would be subcritical even with thick water reflection.

## STORAGE AND TRANSPORTATION\*\*

### Part I: Limits for arrays

4.0 In addressing the nuclear criticality safety of fissile material storage, consideration must be given to the purpose of the storage area. It may be a service area providing temporary storage for materials in process, it may be an area for transient materials in transport, or it may be an area for long-term storage. Each use represents different problems. The number of units, their mass and other properties, the necessary accessibility, and the desired margin of subcriticality help to determine the spacing of material.

*American National Standard Guide for Nuclear Criticality Safety in the Storage of Fissile Materials*,<sup>58</sup> ANSI N16.5-1975/ANS-8.7 (R1987), presents mass limits for spherical units of fissile materials assembled in cubic arrays reflected by thick water. The tabulated arrays have a neutron multiplication factor not exceeding 0.95. While it does not answer all questions, this standard is directly applicable to many storage problems.

4.1 The materials to which the standard is applicable are plutonium,  $^{239}\text{U}$ , and uranium containing more than 30 wt%  $^{235}\text{U}$ , as metals and as wet and dry oxides. The water content of the oxides varies between about 1.4 and 40 wt% (e.g.,  $0.4 \leq \text{H} : \text{U} \leq 20$ ).

4.2 The limits are also conservatively applicable to units not spherical in shape. Each unit is considered centered in its cell, and some guidance is provided for relaxing this requirement as well as for modifying the cell shape.

4.3 The specifications for cubic arrays are applicable to arrays of any shape because of the increased neutron leakage from noncubic arrays. The introduction of hydrogenous material into the space between units is not provided for in the standard; if such moderation is present, the effect must be evaluated by a validated computational technique. The effect on array reactivity due to the introduction of water, as for example from fire protection systems, is strongly dependent on the form of the fissile material and on the mass and spacing of the units. There is, however, an adequate margin in the limits to accommodate incidental moderation, such as would result from enclosing the units in plastic bags that introduce no more than 10 g of polyethylene per kilogram of fissile material.

4.4 Factors for reducing the mass limits are provided for in concrete-reflected arrays. The limits are reduced to 75% of their tabulated values if the concrete thickness is between 120- and 200-mm and to 60% for greater thicknesses. Criteria are presented for pairs of arrays in concrete enclosures. (Slight neutron coupling of arrays separated by 500-mm-thick concrete has been observed experimentally.<sup>59</sup>)

4.5 Each unit of an array must remain subcritical if immersed in water. The possibility of double batching the units in a storage cell should be considered when establishing safe limits and operating procedures. Administrative controls, limited capacity containers, and storage cell design may be useful for the prevention of double batching.

---

\*\* From NUREG Committee, "Nuclear Safety Guide," TID-7016, revision 2, edited by J. T. Thomas, Union Carbide Corporation, 1978.



**4.6** Consideration should be given to other normal and credible abnormal storage conditions that may affect subcriticality. Typical examples<sup>9</sup> of changes in operating conditions that should be considered are:

- flooding, spraying, or otherwise supplying units or groups of units with water, oil, snow (i.e., low-density water), cardboard, wood, or other moderating materials;
- introduction of additional units or reflectors;
- improper placement of units;
- loss of moderator and neutron absorber between units;
- collapse of a framework used to space units;
- change in the density of fissile material during storage;
- substitution of units containing more fissile material than permitted in operations as a result of operational error or improper handling.

### **Alternate Storage Criteria**

**4.7** The following method of criticality control for handling and storing fissile materials represents an extension of the information in ANSI N16.5-1975/ANS-8.7 (R1987). The method is based on the same experimental data and validated calculations<sup>60,61</sup> used for the Standard. The technique is applicable to single storage arrays of any shape reflected by concrete of any thickness and result in storage arrays having a calculated  $k_{eff} \leq 0.93$ .

**4.8** The method consists of a systematic labeling of each fissile material container with a numeric and controlling the total numerics in a storage or process area. This labeling is accomplished by a Criticality Indicator (CI) system and it is the basis for control of criticality.<sup>62</sup> The system requires that each unit be associated with a cell or container volume and assigns a CI to the container by the relation

$$CI = 100 / N \quad (41)$$

where  $N$  is the total number of containers permitted in a storage array. The CI aggregate of a storage area must not exceed 100. The aggregate CI is the sum of the individual CIs, independent of the type of fissile material. All fissile materials present at the storage or handling must be suitably contained and have an assigned CI. Containment other than criticality control may make segregated storage desirable.

**4.9** In accordance with the CI system is applied only to the units of fissile materials described in Table 4.1. This description includes the chemical and isotopic form, the density, hydrogen content, and the mass. The unit may have any shape provided it is subcritical when submerged and the constraints of 4.12 on cell geometry and spacing of units are satisfied. Each unit has been assigned to a mass category indicated by algebraic characters. The CI system is equally applicable to masses of fissile materials at densities less than the specified maximum of Table 4.1.

**4.10** Two category types are described in Table 4.1: those designated by a single letter and those by double letters. The units designated by a single letter are subcritical when submerged and, therefore, their descriptions are suitable for water-reflected masses for general use. Some of the units designated by double letters may be critical if submerged, for example, a sphere of <sup>239</sup>Pu, and therefore require additional assessment if water reflection is a possibility.

4.11 Fissile materials having isotopic content intermediate to those described in Table 4.1 should be considered as having the higher value. For example,  $U(55)O_2$  should be considered as  $U(70)O_2$ , and  $Pu(85)$  as  $Pu(94.8)$ . Plutonium is considered to have less  $^{241}Pu$  than  $^{240}Pu$ . Similarly, an intermediate mass should be assigned to the category representing the larger value.

4.12 The unit-of-mass category may be made up of smaller individually contained quantities, and the units of fissile material should be centered in the cell or container volume to within 10% of the smallest dimension of the cell. Cells may be of any shape<sup>60</sup> provided the ratio of the largest to the smallest cell dimension does not exceed 3. Cell dimensions should provide a surface separation of units not less than 155 mm. Packing materials containing hydrogen, such as thin plastic bags (see 4.3), are allowed.

4.13 The CI value is assigned to a storage cell in an array or to a container and depends on the mass category of the fissile material and on the volume of the cell. Table 4.2 presents the CI values to be assigned to cells containing units of mass categories specified in Table 4.1. Units in the same category are equivalent in an array and may be interchanged without a change in the array neutron multiplication factor. For example, any material of mass category Q contained in a volume of 113.6 l (30 gal.) would be assigned a CI value of 0.33.

4.14 Cell or container volumes different from those given in Table 4.2 may be assigned a CI by interpolation using the relation

$$CI V^2 = CI_1 V_1^2 \quad (42)$$

where  $V_1$  and  $CI_1$  are any tabulated values for the mass category of the fissile material. For example, assume it is desired to store a mass category Q unit in a 300-l container. The value of CI for a container  $V_1$  of 227.1 l is 0.09. The CI value to be used, therefore, is calculated as

$$CI = 0.09 (227.1 \div 300)^2 = 0.5$$

4.15 The effect on array criticality of hydrogenous moderating materials interspersed between the units of a storage array, such as water from sprinklers, should be investigated by a validated calculational technique or by experiment and an appropriate margin of safety applied.

**Table 4.1 Mass Categories for Units of Fissile Material to Which the Criticality Indicator is Applicable.**

| Fissile Material  | U(100)                           |      |      | U(100)O <sub>2</sub> |      |      | U(93.2) |      |      | U(93.2)O <sub>2</sub> |      |      | U(80) |      |      | U(80)O <sub>2</sub> |  |  | U(70) |  |  | U(70)O <sub>2</sub> |  |  | U(50) |  |  | U(50)O <sub>2</sub> |  |  | U(40) |  |  |
|---|----------------------------------|------|------|----------------------|------|------|---------|------|------|-----------------------|------|------|-------|------|------|---------------------|--|--|-------|--|--|---------------------|--|--|-------|--|--|---------------------|--|--|-------|--|--|
| Atomic Ratio,*<br>H:U or H:Pu                               | 0                                |      |      | 0.4 3                |      |      | 0       |      |      | 0.4 3                 |      |      | 0     |      |      | 0.4 3               |  |  | 0     |  |  | 0.4 3               |  |  | 0     |  |  | 0.4 3               |  |  | 0     |  |  |
| Max. density,*<br>g U/cm <sup>3</sup> or Pu/cm <sup>3</sup> | 18.7                             |      |      | 8.3 4.5              |      |      | 18.7    |      |      | 8.3 4.5               |      |      | 16.7  |      |      | 8.3 4.5             |  |  | 18.7  |  |  | 8.3 4.5             |  |  | 18.7  |  |  | 8.3 4.5             |  |  | 18.7  |  |  |
| Mass Category <sup>b</sup>                                  | Mass of Fissile Material* (kg) * |      |      |                      |      |      |         |      |      |                       |      |      |       |      |      |                     |  |  |       |  |  |                     |  |  |       |  |  |                     |  |  |       |  |  |
| A   | 2.7                              | 2.1  | 1.4  | 2.6                  | 2.3  | 1.4  | 2.8     | 2.5  | 1.6  | 3.1                   | 2.9  | 1.7  | 4.2   | 3.6  | 2.0  | 5.3                 |  |  |       |  |  |                     |  |  |       |  |  |                     |  |  |       |  |  |
| B   | 2.8                              | 2.5  | 1.6  | 3.1                  | 2.7  | 1.7  | 3.2     | 3.0  | 1.8  | 3.7                   | 3.4  | 2.0  | 5.0   | 4.3  | 2.4  | 6.3                 |  |  |       |  |  |                     |  |  |       |  |  |                     |  |  |       |  |  |
| C   | 3.2                              | 2.9  | 1.9  | 3.6                  | 3.1  | 1.9  | 3.7     | 3.5  | 2.1  | 4.2                   | 3.9  | 2.3  | 5.8   | 5.0  | 2.7  | 7.2                 |  |  |       |  |  |                     |  |  |       |  |  |                     |  |  |       |  |  |
| D   | 3.6                              | 3.3  | 2.1  | 4.0                  | 3.5  | 2.2  | 4.3     | 4.0  | 2.4  | 4.8                   | 4.4  | 2.6  | 6.6   | 5.7  | 3.1  | 8.3                 |  |  |       |  |  |                     |  |  |       |  |  |                     |  |  |       |  |  |
| E   | 4.1                              | 3.7  | 2.4  | 4.5                  | 4.0  | 2.5  | 4.8     | 4.5  | 2.7  | 5.4                   | 5.0  | 3.0  | 7.4   | 6.4  | 3.5  | 9.3                 |  |  |       |  |  |                     |  |  |       |  |  |                     |  |  |       |  |  |
| F   | 4.5                              | 4.1  | 2.7  | 5.0                  | 4.4  | 2.6  | 5.3     | 5.0  | 3.1  | 6.0                   | 5.6  | 3.3  | 8.2   | 7.1  | 3.9  | 10.4                |  |  |       |  |  |                     |  |  |       |  |  |                     |  |  |       |  |  |
| G   | 4.9                              | 4.5  | 2.9  | 5.5                  | 4.9  | 3.1  | 5.8     | 5.5  | 3.4  | 6.6                   | 6.2  | 3.7  | 9.1   | 7.9  | 4.3  | 11.4                |  |  |       |  |  |                     |  |  |       |  |  |                     |  |  |       |  |  |
| H   | 5.4                              | 5.0  | 3.2  | 6.0                  | 5.4  | 3.4  | 6.4     | 6.1  | 3.7  | 7.2                   | 6.8  | 4.0  | 10.0  | 8.7  | 4.8  | 12.6                |  |  |       |  |  |                     |  |  |       |  |  |                     |  |  |       |  |  |
| I   | 5.8                              | 5.4  | 3.5  | 6.5                  | 5.9  | 3.7  | 7.0     | 6.6  | 4.1  | 7.9                   | 7.4  | 4.4  | 10.9  | 9.5  | 5.2  | 13.7                |  |  |       |  |  |                     |  |  |       |  |  |                     |  |  |       |  |  |
| J   | 6.3                              | 5.9  | 3.8  | 7.0                  | 6.4  | 4.0  | 7.5     | 7.2  | 4.4  | 8.5                   | 8.0  | 4.8  | 11.8  | 10.3 | 5.7  | 14.9                |  |  |       |  |  |                     |  |  |       |  |  |                     |  |  |       |  |  |
| K   | 6.8                              | 6.4  | 4.1  | 7.6                  | 6.9  | 4.3  | 8.1     | 7.6  | 4.8  | 9.2                   | 8.7  | 5.2  | 12.8  | 11.2 | 6.1  | 16.1                |  |  |       |  |  |                     |  |  |       |  |  |                     |  |  |       |  |  |
| L   | 7.3                              | 6.9  | 4.5  | 8.1                  | 7.4  | 4.7  | 8.7     | 8.4  | 5.1  | 9.9                   | 9.4  | 5.6  | 13.8  | 12.1 | 6.6  | 17.4                |  |  |       |  |  |                     |  |  |       |  |  |                     |  |  |       |  |  |
| M   | 7.7                              | 7.4  | 4.8  | 8.7                  | 7.9  | 5.0  | 9.3     | 9.0  | 5.5  | 10.6                  | 10.1 | 6.0  | 14.8  | 13.0 | 7.1  | 18.6                |  |  |       |  |  |                     |  |  |       |  |  |                     |  |  |       |  |  |
| N   | 8.2                              | 7.9  | 5.1  | 9.2                  | 8.5  | 5.4  | 9.9     | 9.7  | 5.9  | 11.3                  | 10.8 | 6.4  | 15.8  | 13.9 | 7.7  | 20.0                |  |  |       |  |  |                     |  |  |       |  |  |                     |  |  |       |  |  |
| O   | 8.7                              | 8.4  | 5.5  | 9.8                  | 9.1  | 5.7  | 10.6    | 10.3 | 6.3  | 12.0                  | 11.5 | 6.8  | 16.9  | 14.9 | 8.1  | 21.3                |  |  |       |  |  |                     |  |  |       |  |  |                     |  |  |       |  |  |
| P   | 9.3                              | 8.9  | 5.8  | 10.3                 | 9.7  | 6.1  | 11.2    | 11.0 | 6.8  | 12.8                  | 12.3 | 7.3  | 17.9  | 15.9 | 8.7  | 22.7                |  |  |       |  |  |                     |  |  |       |  |  |                     |  |  |       |  |  |
| Q   | 9.8                              | 9.5  | 6.2  | 10.9                 | 10.3 | 6.5  | 11.9    | 11.7 | 7.2  | 13.6                  | 13.1 | 7.8  | 19.1  | 16.9 | 9.3  | 24.2                |  |  |       |  |  |                     |  |  |       |  |  |                     |  |  |       |  |  |
| R   | 10.3                             | 10.1 | 6.6  | 11.5                 | 10.9 | 6.9  | 12.6    | 12.4 | 7.8  | 14.4                  | 13.9 | 8.3  | 20.2  | 18.0 | 9.9  | 25.7                |  |  |       |  |  |                     |  |  |       |  |  |                     |  |  |       |  |  |
| S   | 10.8                             | 10.7 | 7.0  | 12.1                 | 11.6 | 7.3  | 13.2    | 13.2 | 8.1  | 15.2                  | 14.8 | 8.8  | 21.4  | 19.1 | 10.5 | 27.2                |  |  |       |  |  |                     |  |  |       |  |  |                     |  |  |       |  |  |
| T   | 11.4                             | 11.3 | 7.4  | 12.7                 | 12.2 | 7.8  | 13.9    | 13.9 | 8.6  | 16.0                  | 15.6 | 9.3  | 22.6  | 20.3 | 11.1 | 28.8                |  |  |       |  |  |                     |  |  |       |  |  |                     |  |  |       |  |  |
| U   | 11.9                             | 11.9 | 7.8  | 13.3                 | 12.9 | 8.2  | 14.7    | 14.7 | 9.1  | 16.9                  | 16.5 | 9.9  | 23.9  | 21.5 | 11.7 | 30.4                |  |  |       |  |  |                     |  |  |       |  |  |                     |  |  |       |  |  |
| V   | 12.5                             | 12.6 | 8.3  | 14.0                 | 13.6 | 8.7  | 15.4    | 16.6 | 9.6  | 17.7                  | 17.4 | 10.4 | 25.2  | 22.7 | 12.4 | 32.1                |  |  |       |  |  |                     |  |  |       |  |  |                     |  |  |       |  |  |
| W   | 13.1                             | 13.3 | 8.7  | 14.6                 | 14.4 | 9.1  | 16.2    | 16.4 | 10.1 | 18.6                  | 18.4 | 11.0 | 26.5  | 24.0 | 13.1 | 33.8                |  |  |       |  |  |                     |  |  |       |  |  |                     |  |  |       |  |  |
| AA  | 13.6                             | 14.0 | 9.2  | 15.3                 | 15.1 | 9.6  | 16.9    | 17.3 | 10.6 | 19.5                  | 19.4 | 11.6 | 27.9  | 25.3 | 13.6 | 35.6                |  |  |       |  |  |                     |  |  |       |  |  |                     |  |  |       |  |  |
| BB  | 14.2                             | 14.7 | 9.6  | 15.9                 | 15.9 | 10.1 | 17.7    | 18.2 | 11.2 | 20.5                  | 20.4 | 12.2 | 29.4  | 26.7 | 14.6 | 37.5                |  |  |       |  |  |                     |  |  |       |  |  |                     |  |  |       |  |  |
| CC  | 14.8                             | 15.4 | 10.1 | 16.6                 | 16.7 | 10.7 | 18.5    | 19.1 | 11.8 | 21.4                  | 21.5 | 12.9 | 30.8  | 28.1 | 15.4 | 32.4                |  |  |       |  |  |                     |  |  |       |  |  |                     |  |  |       |  |  |
| DD  | 15.4                             | 16.2 | 10.7 | 17.3                 | 17.5 | 11.2 | 19.4    | 20.1 | 12.4 | 22.4                  | 22.6 | 13.5 | 32.4  | 29.6 | 16.2 | 41.5                |  |  |       |  |  |                     |  |  |       |  |  |                     |  |  |       |  |  |
| EE  | 16.0                             | 17.0 | 11.2 | 18.0                 | 18.4 | 11.8 | 20.2    | 21.1 | 13.0 | 23.5                  | 23.8 | 14.2 | 33.9  | 31.2 | 17.1 | 43.6                |  |  |       |  |  |                     |  |  |       |  |  |                     |  |  |       |  |  |
| FF  | 16.7                             | 17.8 | 11.7 | 18.7                 | 19.3 | 12.4 | 21.1    | 22.1 | 13.7 | 24.5                  | 25.0 | 15.0 | 35.6  | 32.8 | 17.9 | 45.7                |  |  |       |  |  |                     |  |  |       |  |  |                     |  |  |       |  |  |
| GG  | 17.3                             | 18.6 | 12.9 | 20.2                 | 21.3 | 13.6 | 22.9    | 24.4 | 15.1 | 26.7                  | 27.5 | 16.5 | 39.0  | 36.3 | 19.8 | 47.9                |  |  |       |  |  |                     |  |  |       |  |  |                     |  |  |       |  |  |
| HH  | 18.0                             | 19.5 | 12.9 | 20.2                 | 21.3 | 13.6 | 22.9    | 24.4 | 15.1 | 26.7                  | 27.5 | 16.5 | 39.0  | 36.3 | 19.8 | 50.2                |  |  |       |  |  |                     |  |  |       |  |  |                     |  |  |       |  |  |

\*Read as plutonium having wt% <sup>239</sup>Pu.

<sup>b</sup>Total uranium or total plutonium

Table 4 1 Continued

| Fissile Material  | U(30)                                      |      | U(30)O <sub>2</sub> |      | U(5)O <sub>2</sub> |     | Pu(100)Pu(100)O <sub>2</sub> |      | Pu(94.8)Pu(94.8)O <sub>2</sub> |     | Pu(80) |      | Pu(80)O <sub>2</sub> |      | <sup>235</sup> U |     | <sup>235</sup> UO <sub>2</sub> |  |
|---|--|------|---------------------|------|--------------------|-----|------------------------------|------|--------------------------------|-----|--------|------|----------------------|------|------------------|-----|--------------------------------|--|
| Atomic Ratio, <sup>a</sup><br>H:U or H:Pu                               | 0  | 0.4  | 3                   | 3    | 0                  | 0.4 | 3                            | 0    | 0.4                            | 3   | 0      | 0.4  | 3                    | 0    | 0.4              | 3   |                                |  |
| Max. density, <sup>a</sup><br>g U/cm <sup>3</sup> or Pu/cm <sup>3</sup> | 18.7                                       | 8.3  | 4.5                 | 4.6  | 19.7               | 8.7 | 4.7                          | 19.7 | 8.7                            | 4.7 | 19.7   | 8.7  | 4.7                  | 18.4 | 8.2              | 4.5 |                                |  |
| Mass Category <sup>b</sup>  | Mass of Fissile Material <sup>a</sup> (kg) |      |                     |      |                    |     |                              |      |                                |     |        |      |                      |      |                  |     |                                |  |
| A   | 6.6  | 5.5  | 2.7                 | 4.5  | 1.2                | 1.2 | 0.9                          | 1.2  | 1.3                            | 1.1 | 1.3    | 1.4  | 1.3                  | 1.2  | 1.2              | 0.9 |                                |  |
| B   | 7.9  | 6.5  | 3.2                 | 5.3  | 1.3                | 1.4 | 1.1                          | 1.3  | 1.5                            | 1.2 | 1.6    | 1.7  | 1.5                  | 1.4  | 1.4              | 1.0 |                                |  |
| C   | 9.1  | 7.5  | 3.7                 | 6.1  | 1.5                | 1.6 | 1.3                          | 1.5  | 1.7                            | 1.4 | 1.8    | 1.9  | 1.7                  | 1.8  | 1.6              | 1.2 |                                |  |
| D   | 10.4                                       | 8.6  | 4.2                 | 6.9  | 1.7                | 1.8 | 1.4                          | 1.7  | 1.9                            | 1.6 | 2.0    | 2.2  | 2.0                  | 1.6  | 1.9              | 1.4 |                                |  |
| E   | 11.7                                       | 9.7  | 4.7                 | 7.8  | 1.9                | 2.0 | 1.6                          | 1.9  | 2.2                            | 1.8 | 2.2    | 2.5  | 2.2                  | 2.0  | 2.1              | 1.5 |                                |  |
| F   | 13.0                                       | 10.8 | 5.3                 | 8.8  | 2.1                | 2.3 | 1.8                          | 2.1  | 2.4                            | 2.0 | 2.4    | 2.7  | 2.5                  | 2.2  | 2.3              | 1.7 |                                |  |
| G   | 14.4                                       | 12.0 | 5.8                 | 9.7  | 2.3                | 2.5 | 2.0                          | 2.2  | 2.6                            | 2.2 | 2.6    | 3.0  | 2.7                  | 2.5  | 2.6              | 1.9 |                                |  |
| H   | 15.9                                       | 13.2 | 6.4                 | 10.7 | 2.4                | 2.7 | 2.2                          | 2.4  | 2.9                            | 2.5 | 2.8    | 3.3  | 3.0                  | 2.7  | 2.8              | 2.1 |                                |  |
| I   | 17.3                                       | 14.5 | 7.0                 | 11.7 | 2.6                | 3.0 | 2.4                          | 2.6  | 3.1                            | 2.7 | 3.0    | 3.6  | 3.3                  | 2.9  | 3.1              | 2.2 |                                |  |
| J   | 18.9                                       | 15.7 | 7.6                 | 12.8 | 2.8                | 3.2 | 2.6                          | 2.8  | 3.4                            | 2.9 | 3.2    | 3.8  | 3.5                  | 3.1  | 3.3              | 2.4 |                                |  |
| K   | 20.4                                       | 17.1 | 8.3                 | 13.8 | 2.9                | 3.5 | 2.8                          | 3.0  | 3.7                            | 3.1 | 3.4    | 4.1  | 3.8                  | 3.3  | 3.6              | 2.6 |                                |  |
| L   | 22.0                                       | 18.4 | 8.9                 | 14.9 | 3.1                | 3.7 | 3.0                          | 3.1  | 3.9                            | 3.4 | 3.6    | 4.4  | 4.1                  | 3.5  | 3.8              | 2.8 |                                |  |
| M   | 23.7                                       | 19.8 | 9.6                 | 16.1 | 3.3                | 4.0 | 3.2                          | 3.3  | 4.2                            | 3.6 | 3.8    | 4.7  | 4.4                  | 3.7  | 4.1              | 3.0 |                                |  |
| N   | 25.4                                       | 21.3 | 10.3                | 17.3 | 3.5                | 4.2 | 3.4                          | 3.5  | 4.5                            | 3.9 | 4.0    | 5.0  | 4.7                  | 4.0  | 4.4              | 3.3 |                                |  |
| O   | 27.2                                       | 22.8 | 11.0                | 18.5 | 3.6                | 4.5 | 3.6                          | 3.6  | 4.7                            | 4.1 | 4.2    | 5.4  | 5.0                  | 4.2  | 4.7              | 3.5 |                                |  |
| P   | 29.0                                       | 24.4 | 11.7                | 19.8 | 3.8                | 4.8 | 3.9                          | 3.8  | 5.0                            | 4.4 | 4.4    | 5.7  | 5.3                  | 4.4  | 5.0              | 3.7 |                                |  |
| Q   | 30.9                                       | 26.0 | 12.5                | 21.1 | 3.9                | 5.0 | 4.1                          | 4.0  | 5.3                            | 4.6 | 4.6    | 6.0  | 5.7                  | 4.6  | 5.3              | 3.9 |                                |  |
| R   | 32.9                                       | 27.7 | 13.3                | 22.5 | 4.1                | 5.3 | 4.4                          | 4.1  | 5.6                            | 4.9 | 4.8    | 6.4  | 6.0                  | 4.8  | 5.6              | 4.2 |                                |  |
| S   | 34.9                                       | 29.4 | 14.2                | 23.9 | 4.3                | 5.6 | 4.6                          | 4.3  | 5.9                            | 5.2 | 4.9    | 6.7  | 6.3                  | 5.1  | 5.9              | 4.4 |                                |  |
| T   | 37.0                                       | 31.2 | 14.9                | 25.4 | 4.4                | 5.9 | 4.9                          | 4.5  | 6.2                            | 5.6 | 5.1    | 7.0  | 6.7                  | 5.3  | 6.2              | 4.7 |                                |  |
| U   | 39.2                                       | 33.1 | 15.8                | 27.0 | 4.6                | 6.2 | 5.1                          | 4.6  | 6.5                            | 5.8 | 5.3    | 7.4  | 7.1                  | 5.5  | 6.5              | 4.9 |                                |  |
| V   | 41.5                                       | 35.1 | 16.7                | 28.7 | 4.7                | 6.5 | 5.4                          | 4.8  | 6.8                            | 6.1 | 5.5    | 7.8  | 7.4                  | 5.7  | 6.9              | 5.2 |                                |  |
| W   | 43.8                                       | 37.1 | 17.7                | 30.3 | 4.9                | 6.8 | 5.7                          | 4.9  | 7.2                            | 6.4 | 5.7    | 8.1  | 7.8                  | 6.0  | 7.2              | 5.5 |                                |  |
| AA  | 46.2                                       | 39.2 | 18.6                | 32.1 | 5.0                | 7.1 | 5.9                          | 5.1  | 7.5                            | 6.7 | 5.9    | 8.5  | 8.2                  | 6.2  | 7.6              | 5.7 |                                |  |
| BB  | 48.8                                       | 41.4 | 19.7                | 33.9 | 5.2                | 7.4 | 6.2                          | 5.3  | 7.8                            | 7.1 | 6.0    | 8.9  | 8.6                  | 6.4  | 8.0              | 6.0 |                                |  |
| CC  | 51.4                                       | 43.8 | 20.7                | 35.8 | 5.3                | 7.7 | 6.5                          | 5.4  | 8.2                            | 7.4 | 6.2    | 9.3  | 9.1                  | 6.7  | 8.3              | 6.3 |                                |  |
| DD  | 54.1                                       | 46.2 | 21.8                | 37.9 | 5.5                | 8.1 | 6.8                          | 5.6  | 8.5                            | 7.8 | 6.4    | 9.7  | 9.5                  | 6.9  | 8.7              | 6.6 |                                |  |
| EE  | 57.0                                       | 48.7 | 23.0                | 40.0 | 5.6                | 8.4 | 7.2                          | 5.7  | 8.9                            | 8.1 | 6.6    | 10.1 | 10.0                 | 7.1  | 9.1              | 7.0 |                                |  |
| FF  | 59.9                                       | 51.3 | 24.2                | 42.2 | 5.8                | 8.8 | 7.5                          | 5.9  | 9.3                            | 8.5 | 6.7    | 10.5 | 10.4                 | 7.4  | 9.5              | 7.3 |                                |  |
| GG  | 63.0                                       | 54.1 | 25.4                | 44.5 | 5.9                | 9.1 | 7.8                          | 6.0  | 9.6                            | 8.9 | 6.9    | 11.0 | 10.9                 | 7.6  | 9.9              | 7.6 |                                |  |
| HH  | 66.3                                       | 57.0 | 26.7                | 46.9 | 6.1                | 9.5 | 8.2                          | 6.2  | 10.0                           | 9.3 | 7.1    | 11.4 | 11.4                 | 7.8  | 10.4             | 8.0 |                                |  |

<sup>a</sup>Units designated by double letters may require subcriticality assessment of the submerged unit.



## TRANSPORTATION

4.16 Transport regulations<sup>63</sup> distinguish between "undamaged" and "damaged" packages. The condition of an undamaged package is established by tests that simulate the effects of dropping during handling, extremes of summer heat and winter cold, and rain. The damaged package is defined by a sequence of severe tests for impact, fire, and flooding. A single package must remain subcritical when immersed in water, thus inleakage of water is assumed unless there is a specific individual demonstration before use that such inleakage cannot occur.

4.17 The storage criteria contained in N16.5-1975 or in Tables 4.1 and 4.2 may be used to define limits applicable to Type B, Fissile Class II packages in transport. For Fissile Class II packages, the only control required is a limitation on the number of packages in a vehicle or in a storage area to a specified value,  $N_A$ . The transport index (TI) assigned to a package for criticality control is equal to 50 divided by  $N_A$  where the number of allowable packages satisfies both of the following requirements:<sup>63</sup>

- a. Five times the allowable number of undamaged packages are subcritical in any arrangement closely surrounded by the equivalent of an effectively infinite water reflector.
- b. Twice the allowable number of damaged packages remain subcritical in any arrangement with any distribution of water that is consistent with the results of package tests.

In evaluating the requirements for a damaged package, the fissile material is to be assumed in the most reactive credible configuration consistent with the damaged condition of the package and with the chemical and physical form of the contents. Further, it is to be assumed that water moderation of the array is consistent with the damaged condition of the package and the chemical and physical form of the contents.

4.18 The water-reflected arrays described in N16.5-1975 define acceptable mass loading for the undamaged package. The assignment of the TI is then determined by

$$\begin{aligned} \text{TI} &= 50 \div N_A & (43) \\ &= 250 \div N \end{aligned}$$

where  $N$  is the tabulated number of units corresponding to the mass and cell size in N16.5-1975. The tabulated masses are based on theoretical densities and may be applied to materials at densities not less than 0.25 theoretical.<sup>64</sup> Free volume in packages, allowing possible additional reduction of fissile material density in transport packages, should be discouraged.

4.19 Specifications for the transport of packaged fissile materials may be derived from the CI system since it may be modified to define arrays reflected by 300-mm-thick water, thereby establishing suitable fissile limits for packages in transport. The relation between a category of fissile material in storage, as given in Table 4.1, and a category in transport is given by Table 4.3. The transport mass category of Table 4.3 is then used with Table 4.2 to evaluate the CI for a package. The transport index, TI, is then related to the CI by

$$\text{TI} = 2.5 \text{ CI} \quad (44)$$

**Table 4.3. Relation Between Storage and Transport Mass Categories for Volumes of Fissile Materials**

| Storage |   | Transport |    |
|---------|---|-----------|----|
| A-D     | A | S         | M  |
| E       | B | T         | N  |
| F       | C | U         | O  |
| G,H     | D | V         | P  |
| I       | E | W         | Q  |
| J       | F | AA        | R  |
| K,L     | G | BB        | S  |
| M       | H | CC        | T  |
| N       | I | DD        | U  |
| O       | J | EE        | V  |
| P,Q     | K | FF        | W  |
| R       | L | GG        | AA |
|         |   | HH        | BB |

4.20 As an illustration, use Tables 4.1 through 4.3 to assign transport indices to packages. Assume the product of an operation is a 1.3-kg quantity of Pu(80)O<sub>2</sub> containing less than 1.4-wt% moisture (i.e., H : Pu ≤ 0.04). The oxide is bagged and sealed in one-liter cans. It is desired to ship four such product cans in a 208-liter (55 gal.) package having an inner container that will accommodate the four cans coaxially. The mass category of a 4.6-kg Pu unit as PuO<sub>2</sub> in storage is M, from Table 4.1. The mass category in transport of these units is H, by Table 4.3. The mass category H in a 208-liter container has a CI of 0.01 by Table 4.2, and Eq. (4.4) gives TI = 0.03, to be entered on the package label.

4.21 It will be necessary to analyze the damaged package consistent with the package test results as described in 10 CFR 71, Appendix B, to determine whether (a) or (b) of 4.17 is the limiting condition.

## REFERENCES

9. "American National Standard for Nuclear Criticality Safety in Operations with Fissionable Materials Outside Reactors," N16.1-1975; published by American Nuclear Society, 555 N. Kensington Avenue, La Grange Park, IL.
58. "American National Standard Guide for Nuclear Criticality Safety in the Storage of Fissile Materials," ANSI N16.5-1975/ANS-8.7 (R1987); published by American Nuclear Society, 555 N. Kensington Avenue, La Grange Park, IL.
59. J. T. Thomas, "Experimental Measurements with Arrays of  $U(97.7)F_6$  Neutron-Coupled Through Concrete," *Trans. Am. Nucl. Soc.*, 19, 199 (1974).
60. J. T. Thomas, "The Criticality of Cubic Arrays of Fissile Materials," Oak Ridge Y-12 Plant report Y/CDC-10 (1971).
62. J. T. Thomas, "A Criticality Indicator for Storage of Fissile Materials," Oak Ridge National Laboratory report UCCND/CSD/INF-48 (1975).
63. Title 10, Chapter 1, *Code of Federal Regulations-Energy*, Part 71.



# COMMUNICATION LINKS IN NUCLEAR CRITICALITY SAFETY\*

Thomas P. McLaughlin

## INTRODUCTION

The criticality safety specialist must communicate effectively with personnel at all levels. Information exchange links must exist to management, operations supervisors, operators, plant and equipment designers, specialists in other safety disciplines, and regulators. Another communications path of potentially large value is contact with technical peers at other installations. These seven basic elements of the communication network that impact the criticality safety specialist are shown in Figure 1. Let us consider them individually.

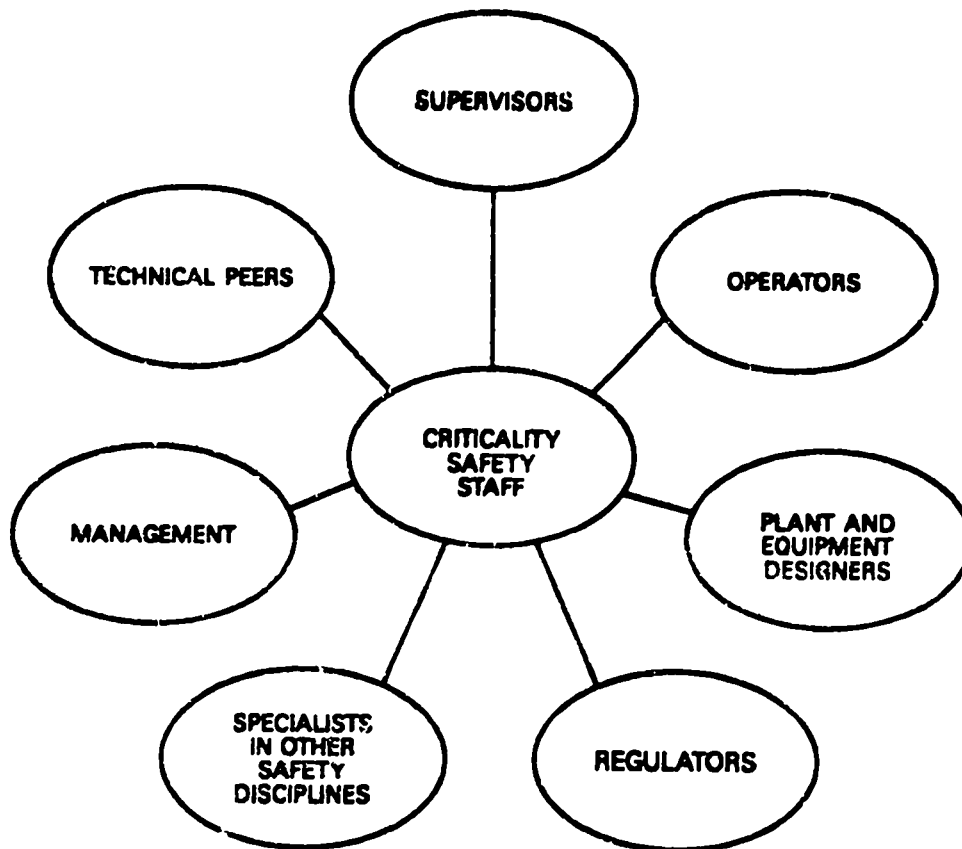

Figure 1. Vital communication links for criticality safety specialists.

---

\* From Los Alamos National Laboratory report LA-UR-82-1875, June 1982 and *ANS Transactions*, Vol. 43, p. 416.

## **MANAGEMENT**

The most important fundamental in the prevention of accidents is the declaration of policy and acceptance of responsibility at the highest levels of management. Criticality safety personnel must keep management informed of the value of an effective criticality safety program and of the resources that are required to perform their functions adequately. For example, process changes allowed by better or additional information on criticality safety aspects that lead or could lead to substantial operating expense reductions or risk reductions should be brought to management's attention.

## **SUPERVISORS**

Criticality safety personnel at Los Alamos spend a large portion of their time interacting with those who supervise operations with fissile material. Since safety is a line management responsibility, information flow both to and from the process supervisors and criticality engineers is essential. Criticality personnel must understand the operations on which guidance is given. Written operating procedures are prepared by the operations supervisors for review by the criticality safety staff but, equally important, the process areas are visited and discussions are held with the supervisors and, sometimes, the operators. At this time, the criticality concerns and implications of the operation are discussed as are potential abnormal operating conditions and their consequences to criticality safety.

We feel that the safety knowledge and practice that is assimilated by the operators is largely that received from the immediate supervisor. Thus, communications with the supervisors is a key ingredient of the criticality safety program at Los Alamos.

## **OPERATORS**

Communications between criticality safety staff and process operators occur in both formal and informal settings. While the majority of the training imparted to the operator is given directly by the supervisor, some formal training is provided by criticality safety personnel. Also, when proposed operating changes, equipment or limit changes, or administrative controls are being discussed with a supervisor, we frequently include the operators who perform the work. During these and any other times we are talking with operators, it is stressed that they are the most important part of the safety of their operation and that they will suffer the consequences of an accident more than anyone else. We solicit their suggestions on how to improve their operations and explain what the criticality controls are and why they are felt necessary.

## **PLANT AND EQUIPMENT DESIGNERS**

Criticality safety is more effective, less costly, and less interfering when designed into plants and equipment than when added afterwards. At Los Alamos, this is stressed to all at supervisory and higher management levels. An example involves a new fissile material storage facility. As we were involved at an early stage, we were able to investigate the impact of loading the structural concrete with boron. While this adds to the cost, it also enables larger SNM storage capacity.

We routinely receive informal communications from process supervisors asking for preliminary guidance on contemplated equipment or process changes. This not only results in criticality safety being built into the revised operation, but also provides a better opportunity to impart criticality safety philosophy and knowledge to the supervisor.

## **OTHER SAFETY SPECIALISTS**

It is obviously the function of every organization's safety program to maintain total risk at an acceptably low level. With finite funds available for safety, it is important that the specialists in different safety disciplines communicate with each other and have some knowledge of the concerns of other safety disciplines. These examples come to mind:

1. There are no criticality alarm systems in our nuclear weapons assembly areas. A spurious criticality alarm leading to the accidental mishandling of high explosives in these areas could have much worse consequences than a criticality accident. While risks are difficult to quantify, our experts in the involved disciplines as well as facility management were involved in reaching this consensus judgment.

2. Most of the locations where fissile material is processed or stored have sprinkler systems for fire suppression. However, water is not generally supportive of criticality safety, and some areas were designed without automatic sprinkler systems. Both of these situations resulted from safety personnel in different specialties discussing their concerns and arriving at what was judged to be the best solution to the specific problem.

3. A third instance involved a health physics technician who had some criticality safety knowledge asking the right question of operations personnel at the right time. This resulted in the operations people consulting with the criticality safety staff before the operation began and led to procedures being revised because of criticality concerns.

## **TECHNICAL PEERS**

At technical meetings, both large and small, and through publications and personal contact, communications among safety specialists is an important element of risk control. Dissemination of accident experience is vital to prevent similar occurrences elsewhere. Sharing new ideas, experiences, and training tools among specialists at different installations will lead to improvements, even in good safety programs.

## **REGULATORS**

A reasonable attitude toward safety regulation is expressed in commentaries on the Atomic Energy Act that appear in the document "Improving the AEC Regulatory Process," dated March 1961, which was prepared by the staff of the Joint Committee on Atomic Energy, under James T. Ramey, then Executive Director. The practical attitude is illustrated by a statement about safety in achieving atomic goals.

"The primary objective of the atomic energy regulatory process should be, of course, to protect the health and safety of the public and employees in industrial and other uses of radiation. As noted earlier, absolute safety is not the objective, however, for this would require discontinuance of all nuclear development.

Therefore, national goals, such as development of nuclear weapons, long-range space exploration through use of rocket-powered vehicles, achievement of economic nuclear power, increased use of atomic energy, and pursuit of basic atomic research, must be considered in determining the reasonableness of safety requirements."

As recognized in this statement, the possession of fissile material presents zero risks.

The Atomic Energy Act requires both the holder and licensee to comply with AEC regulations designed "to protect health and to minimize danger to life and property" or to "provide adequate protection to the health and safety of the public." These regulations are supposed to recognize "widespread participation in the development and utilization of atomic energy for peaceful purposes to the maximum extent consistent" with the above safety aims (and with the common defense and security). Furthermore, the AEC is directed to arrange for technical guidance and safety performance.

The resulting overall picture of safety regulation is fluid, something that adjusts to technical knowledge, instead of arbitrary requirements that are fixed for all time. This is important, because it permits us to view criticality control within its technical bounds, not within the limitations of existing or proposed regulations. Furthermore, it appears that the way is left open for the mutual understanding that was mentioned earlier. To bring about complete understanding, the AEC must keep abreast of technical developments and objectives of the nuclear industry, and licensees and contractors must demonstrate their competence and contribute to the improvement of regulations."

(From "Criticality Control in Operations with Fissile Material," H. C. Paxton, LA-3366, (revised), Los Alamos National Laboratory, November 1972.)

## **SUMMARY**

These seven communications channels are basic to criticality safety. However, like any communications system, people make it work or not work. It is the responsibility of the safety engineer to continually strive to improve the information flow in both directions along each and every link.

# ANS STANDARDS SUBCOMMITTEE 8

April 1992

## PRODUCTS AND PROJECTS

### PRODUCTS

| <u>Number</u> | <u>Brief Title</u>       | <u>BSR Approval</u>                    | <u>Reg. Guide</u>                  |
|---------------|--------------------------|--|------------------------------------|
| ANS-8.1       | Generic Criticality      | 1983; R 11/30/88                       | 3.4 R2 (03/86)                     |
| ANS-8.3       | Criticality Alarm System | 08/29/86 (Rev.)                        | 8.12 R2 (10/88)                    |
| ANS-8.5       | Raschig Rings            | 01/03/86 (Rev.)                        | 3.1 R2 (09/87)                     |
| ANS-8.6       | <i>In Situ</i>           | 1983; R 11/30/88                       | *                                  |
| ANS-8.7       | Storage                  | 1975; R 05/13/87                       | 3.43 R1 (04/79)                    |
| ANS-8.9       | Pipe Intersections       | 04/03/87 (Rev.)                        | 3.45 R1 (04/89)                    |
| ANS-8.10      | Shielded Facilities      | 1983; R 11/30/88                       | *                                  |
| ANS-8.11      | Validation               | Withdrawn 10/07/83;<br>in ANS-8.1-1983 | 3.41 R1 (05/77)<br>withdrawn 04/86 |
| ANS-8.12      | U-Pu Mixtures            | 09/11/87 (Rev.)                        | 3.47 (07/81)                       |
| ANS-8.15      | Actinides                | 1981; R 10/30/87                       |                                    |
| ANS-8.17      | Fuel Element Safety      | 1984; R 08/29/89                       | 3.58 (10/86)                       |
| ANS-8.19      | Administrative Controls  | 1984; R 08/28/89                       | 3.57 (10/86)                       |
| ANS-8.20      | Training                 | 1991                                   |                                    |

\* NRC declined to endorse; no programmatic need.

### ACTIVE PROJECTS

| <u>Writing Group</u> | <u>Brief Title</u>  | <u>WG Chairman</u> | <u>Status</u>                              |
|----------------------|---------------------|--------------------|--|
| ANS-8.1 M(93)        | Generic             | Garcia             |  |
| ANS-8.3 R(92)        | Alarm System        | Reed               | Draft Rev. Prepared                        |
| ANS-8.5 R(92)        | Raschig Rings       | Ketzlach           | New draft rev. in WG                       |
| ANS-8.6 M(92)        | In Situ             | McLaughlin         |  |
| ANS-8.7 R(92)        | Storage             | Hopper             |  |
| ANS-8.9 M(92)        | Pipe Intersections  | Alcorn             |  |
| ANS-8.10 M(93)       | Shielded Facilities | Clayton            |  |
| ANS-8.12 M(92)       | Mixed Oxides        | Clayton/Libby      |  |
| ANS-8.14             | Soluble Absorbers   | Carter             | Exp. date being<br>analyzed, draft revised |
| ANS-8.15 M(92)       | Actinides           | Clayton/Libby      |  |
| ANS-8.19 R(94)       | Administration      | Smith              |  |
| ANS-8.21             | Fixed Absorbers     | Toffer             | Ballot comments<br>with WG                 |
| ANS-8.22             | Moderation Control  | Brown              | Scope ballot                               |
| ANS-8.23             | Emer. Response      | Pruvost            | PINS prepared<br>for approval              |

## HOW STANDARDS ARE DEVELOPED WITHIN THE ANS STANDARDS COMMITTEE\*\*

A standard is developed in a carefully prescribed process that is set forth in the Procedures of the ANS Standards Committee. These procedures include a flow chart of the steps in the process (see Figure 1). This article provides some general information to amplify that contained in the flow chart.

All standards developed within the ANS Standards Committee have the ultimate goal of becoming American National Standards, commonly known as "ANSI Standards." To achieve this goal, the project charter, which describes the proposed standard, and the proposed standard itself must go through a series of reviews and approvals as described below. There must be a compelling and recognized need for a standard to initiate this process. The need for a standard is usually established by a recurring issue that can be addressed by development of a standard. This need may be identified by any individual or committee in the ANS Standards Committee, whose structure is shown in Figure 2.

Once the issue to be addressed is defined, a working group (WG) is selected to prepare a scope statement and title for the proposed standard. The initial responsibility of the WG is to develop a project charter that defines the project, the issue to be addressed (purpose), and how the issue can be resolved by the existence of a standard (need), as well as other information related to the project.

The charter is sequentially reviewed and approved by the responsible subcommittee (SC) and consensus committee (CC), and the Standards Steering Committee (SSC). It is then sent to the Nuclear Standards Board (NSB) of the American National Standards Institute (ANSI) for a broad review by interested participants who are, for the most part, potential users of the proposed standard. Comments may be received throughout this chain of review that can enhance the value of the emerging standard. During this sometimes prolonged process of project charter approval, development of the proposed standard may continue at the working group level.

The writing of a standard is usually achieved through meetings of a working group composed of a small number of individuals who have recognized expertise in the subject. While there is no requirement for a balance of representation on a WG, the membership should include those organizations having a significant interest in the project. The meetings of the WG are supplemented by exchanges of information through the mail, by telephone, and by electronic means.

Subcommittees are established to manage the development of several standards in closely related disciplines, such as reactor operations, waste management, or criticality safety. Members of the subcommittees have expertise in one or more areas in which the proposed standards are being prepared. Again, a balance of representation is not required, but SC membership should include a broad variety of interests. The subcommittee performs the technical review of each proposed standard within its scope of activity. Each SC member is expected to lend his special expertise to the development of standards presented for review. Subcommittee procedures do not require a formal ballot process; indication of SC approval is often achieved by in-committee discussion.

---

\*\* From *ANS News*, August 1989; reprinted by permission.

The SSC has established four consensus committees as depicted in Figure 2. Consensus committees comprise a balance of representation from among various areas of interest, including users, in the work of a specific committee. These committees manage the development of proposed standards within their assigned scopes of responsibility, and they develop consensus for approval of the projects. A formal ballot process is employed to ascertain each member's position on each standard brought before the committee. All comments received must be responded to by the WG; the SC may assist in resolving comments.

A conscientious attempt must be made to resolve concerns expressed by negative votes. Each negative voter is requested to review the response to his comments and to change his vote to affirmative. If he is not satisfied with the attempted resolution of his negative, he may maintain it but must formally state his reasons for doing so. Any outstanding negative positions must be circulated to all members of the CC for review. A member holding an affirmative position may change his vote if he wishes to support those whose votes remain negative.

Public Review (PR) concurrent with the CC ballot is conducted through the auspices of ANSI. The availability of the proposed standard for review for a period of 60 days is announced in the "Standards Action" section of the *ANSI Reporter*. Anyone interested in seeing the document may obtain a copy and provide comments. All comments from PR must be promptly considered.

At the completion of the consensus process, the SSC reviews a "case history" of each proposed standard to certify that all procedures have been implemented. The SSC does not review the document itself.

The final step in the development of a proposed standard is approval by the ANSI Board of Standards Review (BSR). Upon certification by the SSC that consensus procedures have been adhered to, the proposed standard is sent to BSR along with documentation of the ballot results. A "clean case presentation" — where there have been no comments received from PR and there are no outstanding negatives — is assured immediate approval. However, the members of BSR carefully review, and often question, cases where negative results have not been resolved.

Upon satisfaction of all the many steps in the process, a proposed standard emerges as an American National Standard — a remarkable achievement and a credit to all volunteers who made it possible.

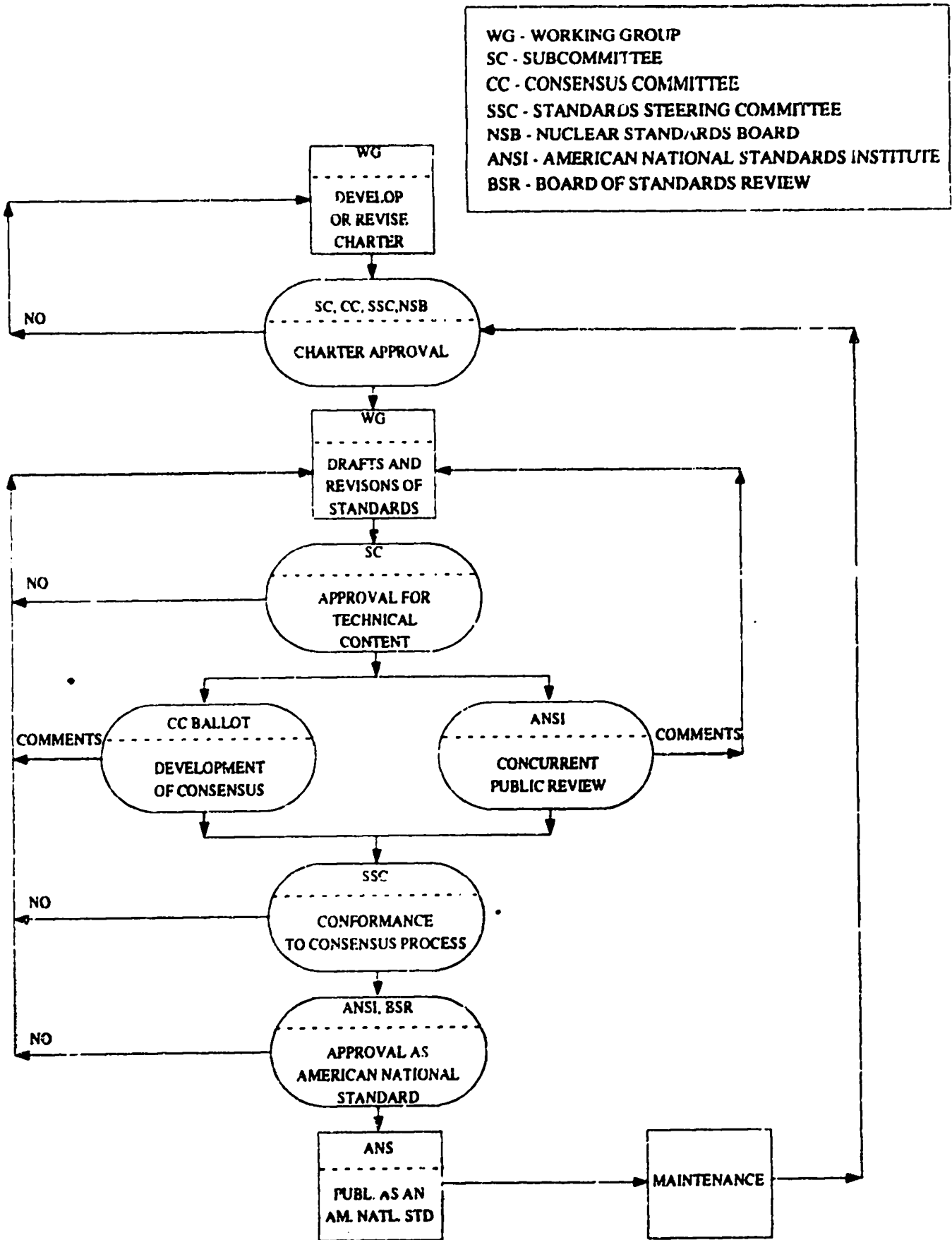

**Figure 1. Steps in the development of a standard.**



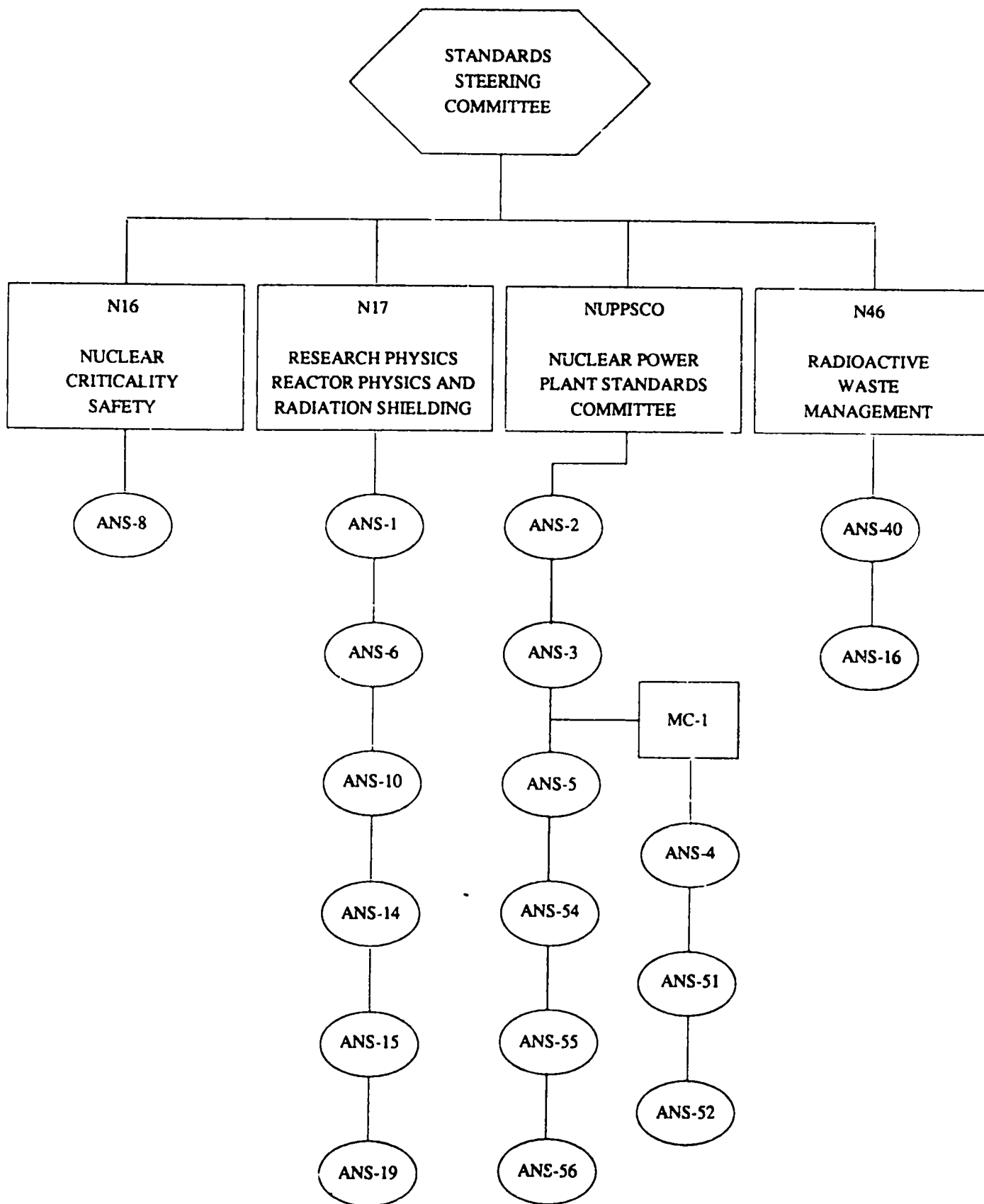

**Figure 2. American Nuclear Society Standards Committee.**

Nuclear Criticality Safety  
is usually defined as  
the *art* of avoiding  
an accidental nuclear excursion

## CATEGORIES OF CRITICALITY ACCIDENTS

Critical Assemblies /  
Reactor Experiments

*approx. 50,000 experiments*

*approx. 30 accidents total*

*6 fatalities*  
*(2 at Los Alamos)*

Process Line

*8 Accidents*

*ALL SOLUTIONS*

*7 U.S. 1 U.K.*

*2 fatalities*  
*(1 at Los Alamos)*

## Process Criticality Accidents

-- All Involved SNM in Solution --

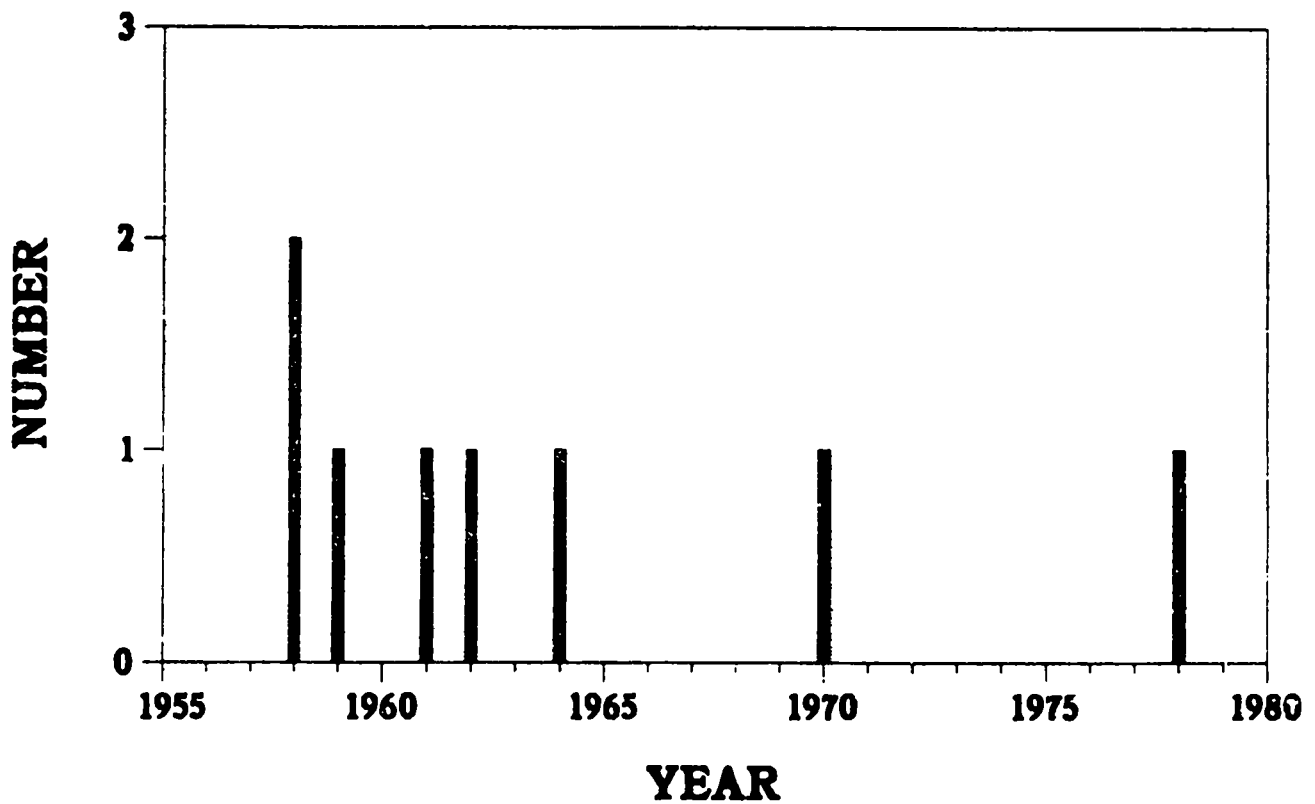

Figure 1. Process criticality accidents involving special nuclear material in solution.

## **SOLUTION ACCIDENTS**

- 1- Y-12 - Oak Ridge - June 1958
- 2- Los Alamos - December 1958
- 3 Idaho Chemical Processing Plant - October 1959
- 4- Idaho Chemical Processing Plant - January 1961
- 5- Hanford Works - April 1962
- 6- Wood River Junction - Rhode Island - July 1964
- 7- Windscale Works - Great Britain - August 1970
- 8- Idaho Chemical Processing Plant - October 1978

### 3 Los Alamos Criticality Accidents Causing Fatalities

#### Critical Assemblies

| <u>Date</u>  | <u>Location</u>   | <u>System</u>     | <u>Cause</u>         | <u>Yield (fissions)</u>                  | <u>Quenching Mechanism</u> | <u>Dose</u> | <u>Time to Death</u> | <u>Dose to Others Involved</u> |
|--------------|-------------------|-------------------|----------------------|--|----------------------------|-------------|----------------------|--------------------------------|
| Aug 21, 1945 | Los Alamos Canyon | Core and WC refl. | Hand Stack Reflector | $1 \times 10^{16}$<br>$\Delta p = .10\%$ | Thermal Expansion          | 800 rem     | 28 days              | 50 rem                         |
| May 21, 1946 | TA-18             | Core and Be refl. | Hand Stack Reflector | $3 \times 10^{15}$<br>$\Delta p = .01\%$ | Thermal Expansion          | 900 rem     | 9 days               | 135, 116, 93, 41, 18, 18 rem   |

#### Process Line

| <u>Date</u>  | <u>Location</u> | <u>System</u>               | <u>Cause</u> | <u>Yield (fissions)</u> | <u>Quenching Mechanism</u>          | <u>Dose</u> | <u>Time to Death</u> | <u>Dose to Others Involved</u> |
|--------------|-----------------|-----------------------------|--------------|-------------------------|-------------------------------------|-------------|----------------------|--------------------------------|
| Dec 30, 1958 | DP Site         | Pu rich solids and solution | Agitator     | $1.5 \times 10^{17}$    | Macro Bubbling<br>Thermal Expansion | 12000 rem   | 36 hours             | 135, 54 rem                    |

# Los Alamos 1981

## 3.2-kg Pu Buildup in Waste Tank

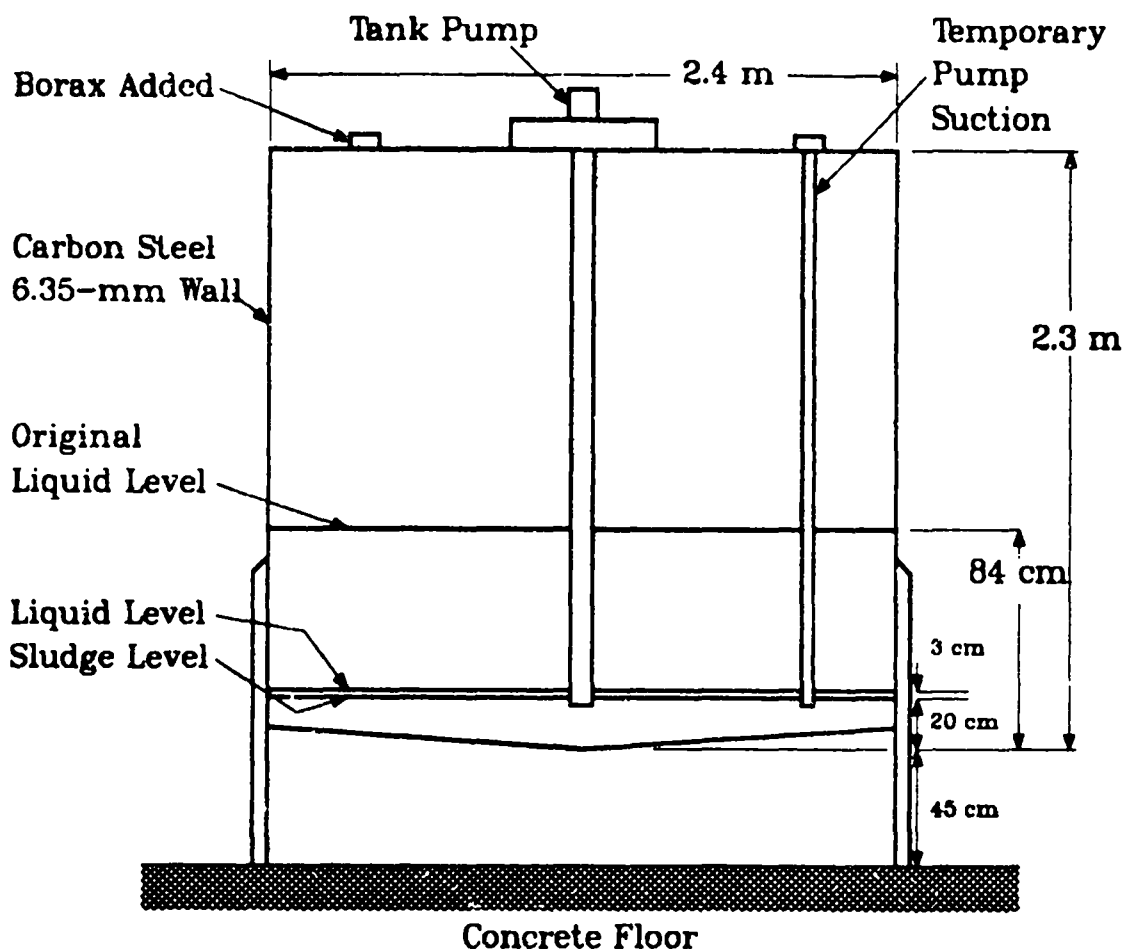

Figure 2. Caustic waste holding tank

# A REVIEW OF CRITICALITY ACCIDENTS\*

W. R. Stratton

revised by D. R. Smith

## INTRODUCTION

Since the beginning of the atomic energy industry, there have been no less than 41 occasions when the power of fissile systems became uncontrollably large because of unplanned or unexpected changes in the system reactivity. Some of these power excursions were planned more moderately, but for various reasons the energy release was significantly larger than expected. Of these 41 cases, seven caused nine deaths, two of which occurred in the hectic years near the end of World War II.

The accidents that occurred in fissile material processing operations are reviewed here, along with what is thought to be the first fission accident. The two critical experiment accidents at Los Alamos that resulted in fatalities during the 1940's are also included.

## PART I

### PROCESS ACCIDENTS

#### (I-1) The Y-12 Chemical Processing Plant, Oak Ridge, Tennessee, June 16, 1958<sup>2,3,4</sup>

*(Uranium process solution combined with water in a 55-gallon drum, unshielded operation)*

The nuclear accident occurred in a processing area in which enriched uranium was recovered from various materials by chemical methods on a complex of equipment. This recovery system was being remodeled at the time, and the situation was further aggravated by an inventory in progress. The inventory required disassembly, cleaning, reassembly, and leak testing of certain pieces of equipment, particularly several long, 5-inch-diameter pipes used for storage of aqueous solutions of <sup>235</sup>U. The spacing and dimensions of these pipes were such that contained solutions could not become critical. The inventory procedures extended over several days, and operations had been re-established in the area immediately ahead of that in which the accident occurred. As a consequence of this overlapping of operations, and irregularities in the operation of some valves, a quantity of enriched uranium solution was inadvertently transferred from the area already in operation into the one still undergoing leak testing. It has been established that the flow pattern from the storage pipes into a drum intended to receive water that had been used for leak testing was such that the accumulated

---

\* From Nuclear Criticality Information report DOE/NCT-04, March 1989.



solution preceded the water. The dimension of the 55-gallon drum (about 22-inches in diameter) permitted the solution to become critical. Further flow of water first increased the uncompensated reactivity for about 11 minutes, then decreased it, and the solution became subcritical after about 20 minutes.

When the system became critical, the solution volume was thought to have been 56 liters, a cylinder 55.2-centimeters in diameter and 23.45-cm high. The  $^{235}\text{U}$  mass at this time was 2.1 kilograms; 0.4 kg was added later while water was diluting the system further. During the excursion, a radiation detection instrument, consisting of a boron-lined ionization chamber, amplifier, and recorder, was operating about 1,400 feet away and cross-wind from the area of the accident. The trace showed that the radiation intensity first drove the pen off-scale and about 15 seconds later drove it off-scale again. During the next 2.6 minutes, the trace oscillated an indeterminate number of times. It is possible that these oscillations were decreasing in amplitude, but this was not established by examination of the trace. This average high-intensity field was followed by a slowly decreasing ramp, described as about five times background, for 18 minutes.

The power history can be reconstructed only qualitatively. The most likely source of initiation was neutrons from the reaction  $^{16}\text{O}(\alpha, n)^{19}\text{Ne}$  between  $^{234}\text{U}$  alpha particles and the oxygen in the water, so that it is possible that the system reactivity slightly exceeded prompt criticality before the first excursion. The reactivity insertion rate was about 17 cents per second at this time, a relatively low value, and the size of the first spike must have been determined by the reactivity attained when the chain reaction started. Although there is no way to be sure of this, a reasonable guess is that the first spike contributed about  $10^{16}$  of the total yield of  $1.3 \times 10^{18}$  fissions. The second oscillation or spike (which drove the recording pen off-scale) occurred in 15 seconds, quite a reasonable time for existing bubbles to have left the system. The oscillations for the next 2.6 minutes appeared to be no greater than about 1.7 times the average power.

The power trace suggests that most of the fissions occurred in the first 2.8 minutes, in which case the average power required to account for the observed yield was about 220 kilowatts. After this, the system probably started to boil, causing a sharp decrease in density and reactivity and reducing the power to a low value for the final 18 minutes.

During this accident,  $1.3 \times 10^{18}$  fissions occurred. There was no damage or contamination to process equipment. Eight people were irradiated in the amounts c. 461, 428, 413, 341, 298, 86.5, and 28.8 rem. At least one person owes his life to the fact that prompt and orderly evacuation plans were followed. One person survived 14½ years, one 17½ years, the status of one is unknown, and five were alive 29 years after the accident.

This accidental excursion was promptly simulated in the Oak Ridge National Laboratory to provide information regarding probable radiation exposures received by the people involved in the accident.

The plant was returned to operation within three days.

## **(I-2) The Los Alamos National Laboratory — December 30, 1958<sup>5,6</sup>**

*(Separated phases in a plutonium process tank, unshielded operation)*

The operations carried out at the facility where this accident occurred were those chemical steps used to purify and concentrate plutonium from slag, crucible, and other "lean" residues resulting from the recovery processes. Typical and

expected solutions contained less than 0.1 grams per liter plutonium and traces of americium. At the time of the accident, an annual physical inventory was in progress so that the normal flow into the area was interrupted, and residual materials in all process vessels were to be evaluated for plutonium content. Reconstruction of significant events indicates that unexpected plutonium-rich solids, which should have been handled separately, were washed from two other vessels into a single, large vessel that contained dilute aqueous and organic solutions. After removal of most of the aqueous solution from this vessel, about 200 l of material remained, including nitric acid wash, and was transferred to an 850-l, 96-cm-diameter stainless steel tank in which the accident occurred. This tank shown in Figure 3 and represented in Figure 4, already contained about 295 l of a caustic-stabilized aqueous-organic emulsion, and the added acid is believed to have separated the liquid into two phases.

The bottom layer of 330 l is thought to have contained 60-g of plutonium; the organic layer of 160 l contained 3.27 kg of plutonium (Fig. 4). Estimates indicate that this 20.3-cm-thick layer was perhaps 5\$ below delayed criticality and that the critical thickness was 21 cm. When the motor drive of a stirrer was started to mix the solutions, the initial reaction was to force solution up and along the tank wall, displacing the outer portion of the upper layer and thickening the central region. This motion changed the system reactivity from about 5\$ subcritical to superprompt critical, and a power excursion occurred. None of the gamma-sensitive recording meters within range of the accident showed a definitive trace; they suggested, however, that there was but a single spike. The excursion yield was  $1.5 \times 10^{17}$  fissions.

From post-excursion experiments of a similar geometry, it was observed that there was no apparent delay between start and full speed of the stirrer at 60 revolutions per minute, after one second (1 revolution) there was a visible movement or disturbance on the surface, and in two or three seconds, the system was in violent agitation. From these observations, it can be concluded that the system could have been made critical in about one second, and in no more than 2 or 3 seconds it must have been subcritical and the excursion was terminated.

From the above time intervals and the estimate that initially the system was 5\$ subcritical, the reactivity insertion rate would have been about 5\$ per second. This, with coefficients appropriate for the solution, lead to a spike yield of  $2.2 \times 10^{17}$  fissions with the spike completed in 1.65 seconds, 0.45 seconds after prompt criticality was reached. To obtain the observed yield ( $1.5 \times 10^{17}$  fissions) in a single spike, the reactivity insertion would have to be reduced to about 2\$ per second. As this is inconsistent with the time involved, about 3 seconds before complete mixing, the only alternative is to assume that the rate was somewhat less than 5\$ per second and that the excursion was terminated in about 3 seconds by the stirring action. Apparently then, the initial action was thickening of the upper layer, followed almost immediately by distortion into a less critical, vortex-like geometry by the action of the stirrer blades.

This entire plutonium process area had been reviewed by the Laboratory's Nuclear Criticality Safety Committee about one month before the accident. Plans were underway to replace the large volume process vessels with favorable geometry tanks. Administrative controls had been used successfully for more than seven years, and were considered acceptable for the additional six to eight months that would have been required to obtain and install the improved equipment.

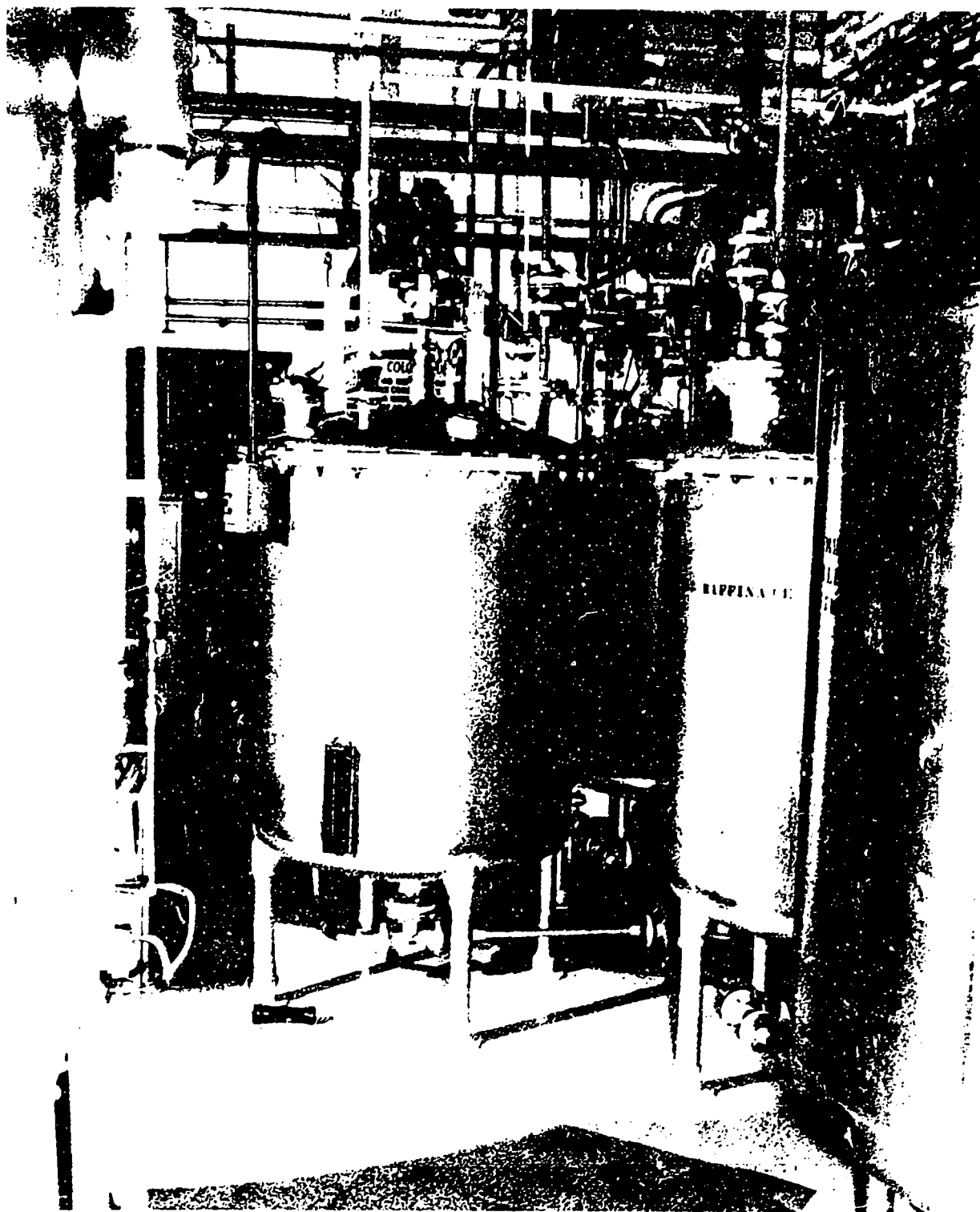

**Figure 3. Process vessel in which the 1958 Los Alamos plutonium solution accident occurred.**

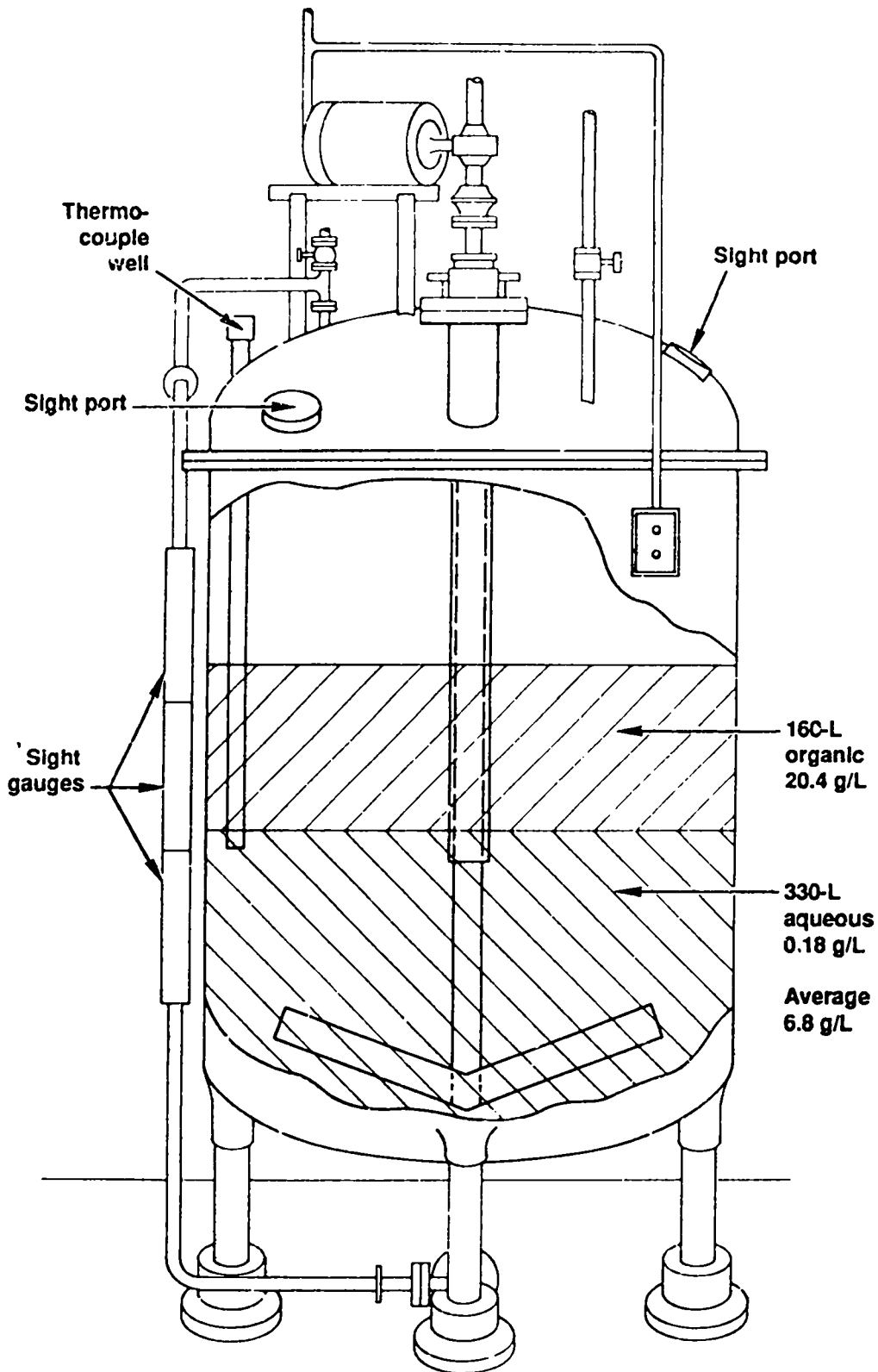

**Figure 4. Configuration of the 850-Liter plutonium solution tank prior to the accident.**

Following the accident, procurement of favorable geometry equipment was accelerated and installation was completed before restarting operations. Improvements in techniques for sampling of solids were implemented to provide enhanced safety, and the importance of adherence to procedural controls was emphasized.

**(I-3) The Idaho Chemical Processing Plant, Idaho Reactor Testing Area  
— October 16, 1959<sup>7</sup>**

*(Enriched Uranium solution siphoned from a favorable to a non-favorable geometry, shielded operation)*

This accident occurred in a chemical processing plant that accepts, among other items, spent (used) fuel elements from various reactors. The active material involved (34 kg of enriched uranium, 93%  $^{235}\text{U}$  in the form of uranyl nitrate concentrated to about 170-g  $^{235}\text{U}/\text{l}$ ) was stored in a bank of favorable geometry containers. During an air-sparging operation, a siphoning action was inadvertently initiated, transferring about 200 l of this solution to a 5000-gal tank containing about 600 l of water. The resulting power excursion created  $4 \times 10^{19}$  fissions, sufficient to boil away nearly half of the 800-l solution volume. The siphoning rate was 13 liters per minute, but the reactivity insertion rate depended on the degree of mixing; it could have been as high as 25 cents per second. Since the 9-foot diameter tank was lying on its side, the solution configuration was a near-infinite slab, and waves in the solution could have caused large fluctuations in the system reactivity. Afterward, much of the uranyl nitrate was found to be crystallized on the inner walls of the tank, and most of the water had evaporated.

The power history is a matter of conjecture — one can guess that it was similar to that of the Y-12 accident. It is not unreasonable to assume an initial spike of at least  $10^{17}$  fissions, followed by power oscillations, and finally by boiling for 15 to 20 minutes. The very large yield is a result of the large volume of the system and the long time rather than of the violence of the excursion. Personnel received no significant gamma or neutron doses because of thick shielding, but airborne fission products resulted in beta dosages of 50 R (one person), 32 R (one person), and small amounts for 17 persons, all obtained while the building was being evacuated. The equipment involved in the excursion was not damaged.

**(I-4) The Idaho Chemical Processing Plant, Idaho Reactor Testing Area  
— January 25, 1961<sup>8</sup>**

*(Uranium process solution transferred from a favorable to a non-favorable geometry vessel, shielded operation)*

This plant accident is thought to have been caused by a bubble of high-pressure air (residual from an earlier line unplugging operation) forcing about 40 liters of 200-g/l uranyl nitrate solution up a pipe of 5-in diameter into a vapor-disengagement cylinder of 2-ft diameter and 4-ft high. The excursion occurred in the cylinder, probably as a single power spike since the geometry change must have resulted in a fast transient. The yield was  $6 \times 10^{17}$  fissions, but no estimates for the reactivity and power history are available.

Previous to the run with this solution, the portion of the plant involved had been idle for about 12 months. Two pumps pertinent to the operation were, at best, working poorly, and a line may have been plugged. Apparently the air

bubble was caused by efforts to cure these difficulties.

In this accident, irradiations were trivial because the process cell provided extensive shielding. The solution was contained, and plant operations were resumed within an hour.

#### **(I-5) The Hanford Works, Richland, Washington — April 7, 1962<sup>9,10,11</sup>**

*(Plutonium solution incorrectly siphoned)*

This process plant (Recuplex system) accident involved the clean-up of the floor of a solvent extraction hood, a product receiver tank that could overflow into this hood, a temporary line running from the hood floor to a transfer tank (approx. 18 inches in diameter and 69-l capacity), and the apparent improper operation of valves. The testimony of witnesses and operators and their technical findings of the investigating committee are not in full agreement, and the final triggering mechanism cannot be determined. Although other mechanisms cannot be ruled out, the most plausible (and simplified) course of events is as follows: 1) the receiver tank overflowed into the hood, leaving solution containing about 45 grams Pu per liter on the floor and in the sump; 2) the operator (contrary to orders) opened the valve that allowed this solution to be lifted to the transfer tank; and, 3) the later addition of aqueous solution (10-30-l at 0.118-g Pu/l) led to the excursion as a result of additional moderation following mixing and/or de-aeration of the contents of the transfer tank.

The total excursion yield in the transfer tank was  $8 \times 10^{17}$  fissions with the initial power spike estimated to be no more than  $10^{16}$  fissions. Following this spike, the tank was supercritical for 37.5 hours with the power steadily decreasing. Activation of the building criticality alarm resulted in prompt evacuation. Of the 22 people in the building at the time (a Saturday morning), only three received significant exposures to radiation. These were 110, 43, and 19 rem.

The accident itself caused no damage or contamination but did stimulate final shutdown of the plant. The Recuplex operation was designed originally as a pilot plant and only later converted to production. Before the accident a new plant had been authorized.

Response to this accident was unique in that a small, remotely controlled, television-equipped robot was used to reconnoiter the building interior, fix precisely the point of the accident (through the use of an attached, highly directional gamma probe), read meters, deposit instrumentation at specified locations, and operate valves upon demand.

Dr. E. D. Clayton has suggested an interesting shutdown mechanism for this reaction. A central pipe entering the bottom of the vessel in which the reaction occurred was found to contain dibutyl phosphate, with a significant loading of plutonium. It is suggested that this started as a layer of tributyl phosphate in carbon tetrachloride on top of the aqueous plutonium solution, serving as a reflector necessary to achieve criticality. The heat and radiation from the fission reaction could have driven off the carbon tetrachloride and converted the remaining organic largely to dibutyl phosphate. The heavier dibutyl phosphate, having taken up plutonium, could have then gone to the bottom of the vessel and into the pipe where it would have little contribution to the system reactivity. As is often the case after an accident, it is difficult to evaluate the validity of this suggestion, but it does appear to provide a consistent explanation.

**(I-6) The Wood River Junction, Rhode Island, Scrape Recovery Plant —  
July 24, 1964<sup>12,13</sup>**

*(Concentrated uranyl nitrate solution hand-poured into a non-favorable geometry container, two power excursions)*

This chemical processing plant accident occurred in the United Nuclear Corporation's <sup>235</sup>U scrap recovery facility. The plant was designed to recover highly enriched uranium from unirradiated scrap material resulting from the fabrication of reactor fuel elements. As an example of the difficulties that should be expected with a new operation, an unexpectedly large amount of uranium-contaminated trichloroethane (TCE) solution had accumulated. The uranium in this solution (very low concentration) was recovered by mixing the TCE with sodium carbonate solution. Before July 17, this operation was performed by hand in small bottles (5-inches in diameter, 11-liter volume) of favorable dimensions, but on that date, because of the large amount of solution, the operation was shifted to a sodium makeup tank of approximately 18-inches in diameter and 25-inches in depth — not a favorable geometry for concentrated solutions, which, however, were not expected in this particular area.

On the day before the accident, a plant evaporator failed to operate properly, and a plug of crystals was found in a connecting line. These crystals were dissolved with steam, and the resulting concentrated solution (240-g <sup>235</sup>U/l) was drained into polyethylene bottles identical to those that normally held the very low concentration in TCE. A bottle of this concentrated solution was mistaken for TCE solution and the operator poured it into the makeup tank. As the tank contained 41 liters of sodium carbonate solution and was being agitated by an electric stirrer, the critical state was reached, and a reaction occurred when nearly all of the uranium had been transferred. This excursion of  $1.0$  to  $1.1 \times 10^{17}$  fissions created a flash of light, splashed about 20% of the solution out of the makeup tank, and knocked the operator to the floor. He was able to get to his feet and run from the area to an emergency building some 200 yards distance, but his radiation dose, estimated to be 10,000 rad, was fatal and he died 49 hours later.

One and one-half hours after the excursion, two men entered the area in order to drain the solution into safe containers. In attempting this, they turned off the stirrer as they left, and, apparently, the change in geometry created, as the stirrer-induced vortex relaxed, added enough reactivity to create a second excursion (or possibly a series of small excursions). The estimated yield of this excursion was  $2$  to  $3 \times 10^{16}$  fissions, and in this case no solution was splashed from the tank. The occurrence of this second excursion was not established until much later, as the alarm was still sounding because of the first event.

During this situation involving two distinct periods of supercriticality, one man received a fatal radiation dose, while the two men who were involved in the second excursion received doses estimated at between 60 and 100 rads, apparently while they were departing.

Other persons in the plant received only trivial irradiations, and no physical damage was done to the system, although cleanup of the splashed solution was necessary. The total energy release was equivalent to  $1.3 \pm 0.25 \times 10^{17}$  fissions.

(I-7) Windscale Works, Great Britain — August 24, 1970<sup>14,15</sup>

*(A solvent-extraction plutonium recovery plant)*

This was the smallest criticality accident known to have occurred in any process area, and also one of the more interesting and complex because of the intricate sequence of configurations that characterized the accident.

The plant involved was used to recover plutonium from miscellaneous scrap, and processes were thought to be subject to very effective controls. Recovery operations started with a dissolver charge that was limited to about 300 grams of plutonium. Following dissolution, the supernatant was transferred through a filter to a conditioner tank where the concentration was adjusted to 6- to 7-g Pu/l, less than the minimum critical concentration.

From the conditioner the solution was vacuum-lifted to a transfer tank. Completion of this transfer resulted in breaking the vacuum and permitted the transfer tank to drain into a constant volume feeder, which supplied a favorable geometry-pulsed solvent extraction column. The connection from the transfer tank to the constant volume feeder was through a 25-foot-deep trap, or lute, which was present to eliminate any potential backflow and thus control contamination. This configuration is shown in Figure 5.

The excursion occurred at the completion of the transfer of a 50-l batch of solution from the conditioner to the transfer tank. The small size of the excursion (about  $10^{15}$  fissions) and the brief duration (less than 10 seconds) precluded any energy-based shutdown mechanism for the excursion. Radiation measurements indicated the excursion occurred in the transfer tank, but the solution from the conditioner was too lean to sustain criticality, and the total quantity of plutonium in this batch (300 g) was about 60% of the minimum critical mass. Thus it was feared that the transfer tank might contain large quantities of solids, perhaps tens of kilograms. It was feared that any disturbance of the system might stimulate another and perhaps much larger excursion.

A 6 in diameter hole was cut through the concrete roof, and the vacuum line was opened. The interior of the transfer tank was inspected with a fiber-optics system developed specifically for this recovery operation, and was found to contain liquid. A small-diameter plastic line was inserted into the tank and 2.5 liter aliquots were siphoned to a collection point in an adjacent building. Inspection of the liquid revealed tributyl phosphate / kerosene with a specific gravity of 0.96 grams per milliliter and containing 55-g Pu/l. Aqueous liquor from the conditioner had a specific gravity of 1.3. A 25-foot column of aqueous liquor in one arm of the trap was sufficient to balance approximately 33.8 ft of solvent in the other arm. Thus any solvent introduced into the transfer tank was held there, and an accumulation could build up until the volume corresponded to a height of 33.8 feet above the bottom of the trap. Some 39 l were present, containing about 2.15 kg of Pu. Degradation of the solvent indicated it had been trapped in the transfer tank for at least several months, and perhaps for as long as two years. Each time a batch of aqueous liquor was processed through the transfer tank, the solvent would strip some plutonium from the aqueous. With each transfer, the plutonium concentration in the tributyl phosphate / kerosene continued to increase. The operation that resulted in the excursion probably added about 30 g of plutonium to the solvent. Periodic plant cleanout by flushing nitric acid through the system presumably reduced the plutonium concentration in the trapped solvent. The concentration may thus have slowly increased, then been abruptly reduced, and gone through several such cycles until the system finally achieved criticality.



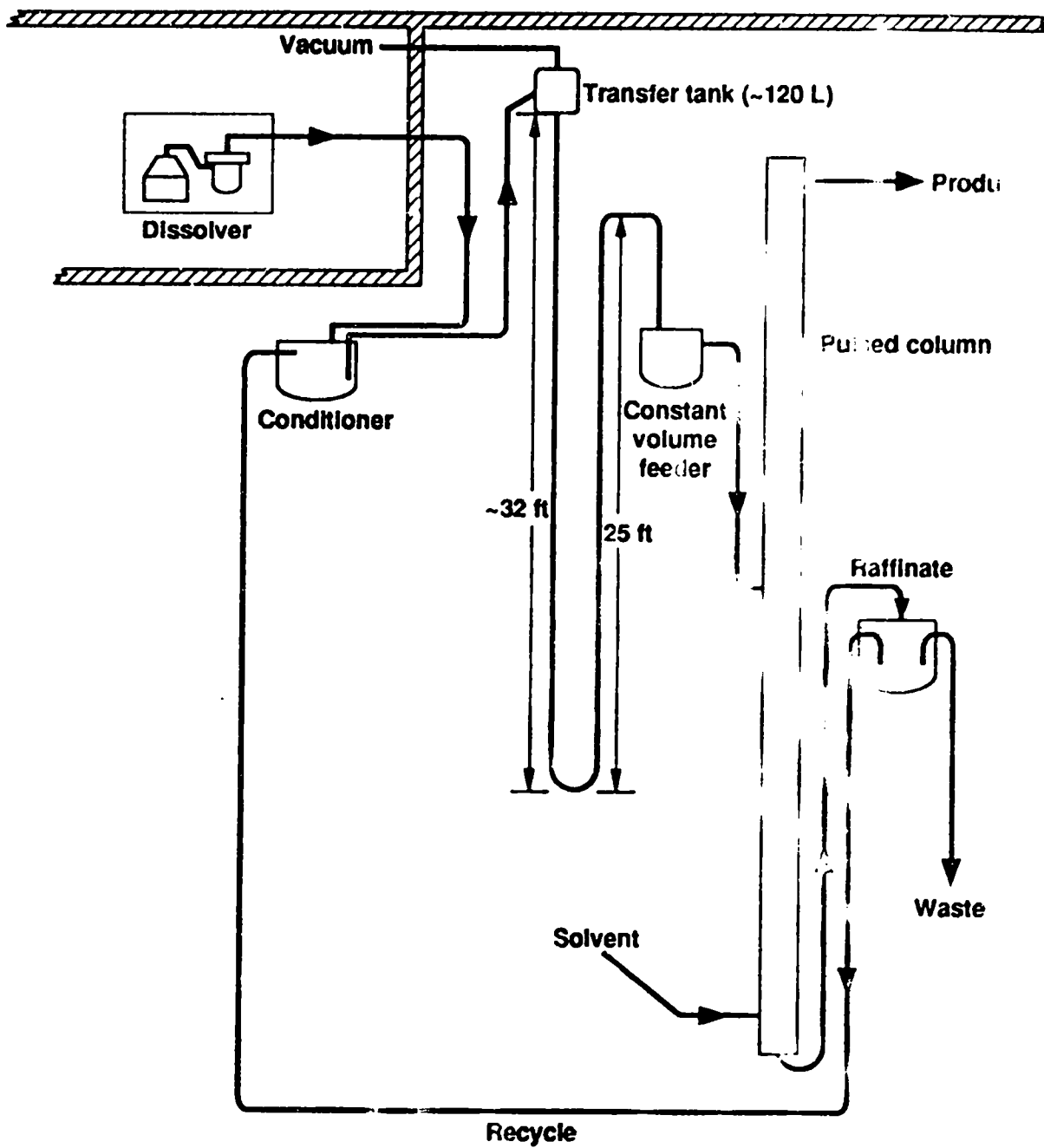
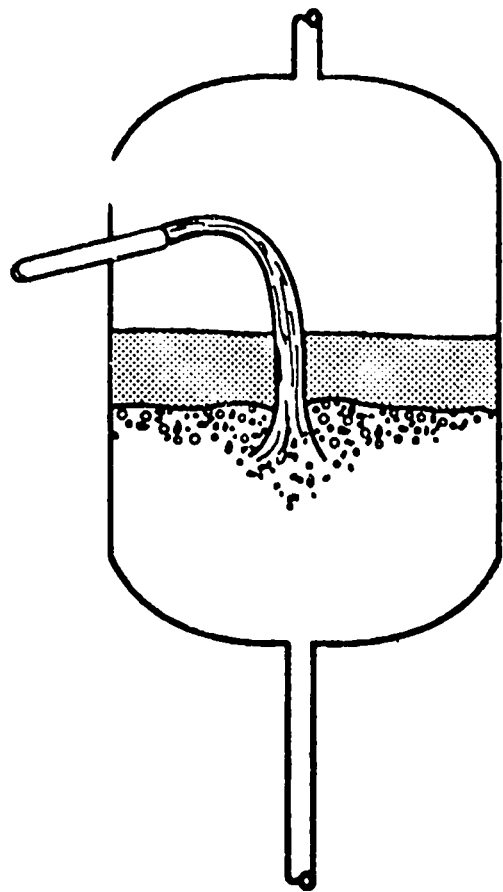
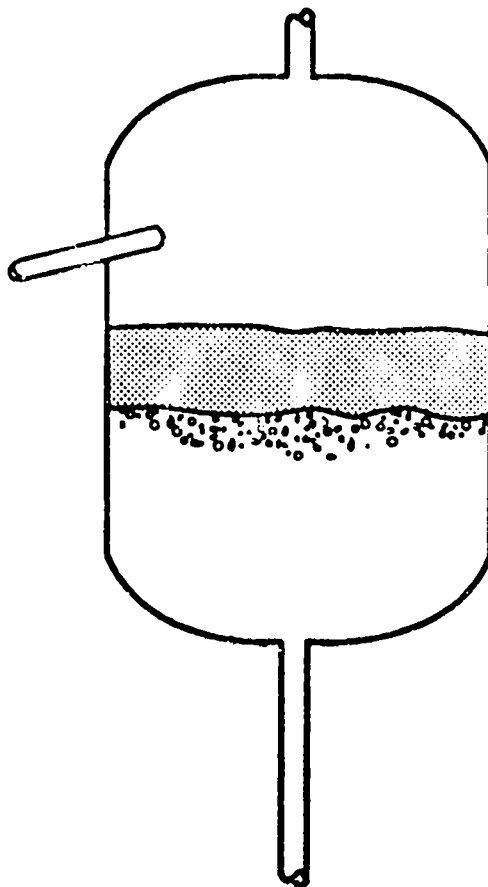

Figure 5. The British Nuclear Fuels, Ltd., process at Windscale.

Vacuum



(a)



(b)

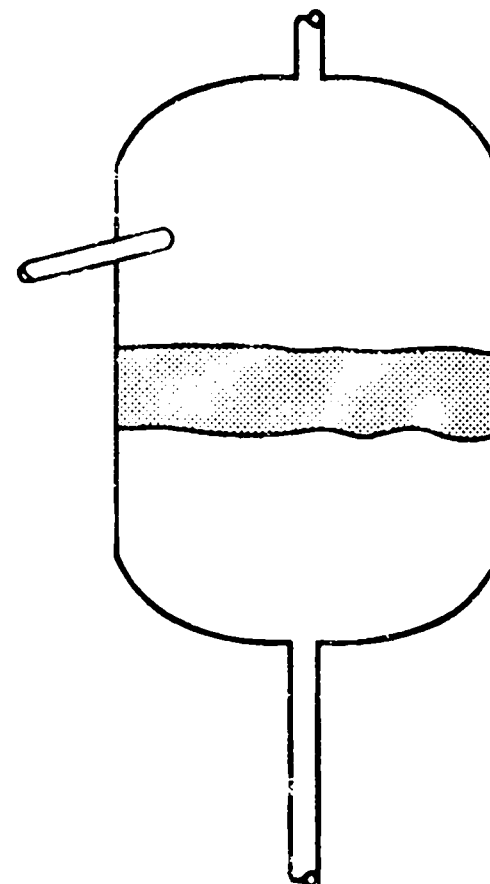

(c)

Figure 6. Solution transfer in the Windscale process line.

The shutdown mechanism was still in question, however, because the rate of drainage of the transfer tank was not sufficient to account for the brief duration of the excursion.

A transparent plastic mockup of the transfer tank was used to observe the configuration of the liquids during the transfer. Features of the transfer mechanism are illustrated in Figure 6. Case A illustrates the situation existing during most of the transfer. Rich (55-g/l) organic is floating on top of lean aqueous liquor (6-7 g/l). The aqueous stream pouring into the center of the tank provides a region of low reactivity. Between the organic and aqueous is a region of mixed phases, about 3-in thick near the axis of the tank. This configuration (A) is subcritical.

The situation just after the transfer was completed is represented by Case B. Here the central plug of aqueous liquor has disappeared, the region of mixed phases is still present, and this configuration has a maximum value of the multiplication factor.

Case C represents the separation of the two phases that occurred within a few seconds of the completion of the transfer. Monte Carlo calculations have indicated that the reactivity of Case B is about 5% greater than Case A, and about 10% to 15% greater than Case C. Apparently, a sufficient interval was present between nitric acid washes for the plutonium concentration to increase until the system became slightly supercritical at the conclusion of a transfer, tripping the criticality alarm.

Two people were present in the plant at the time of the accident. One received an estimated dose of 2 rads, the other less than 1 rad. This excursion illustrates the subtle ways in which an accident can occur during solution processing. The deep trap was considered a safety feature for the control of contamination but it contributed directly to the criticality accident.

The difficulty in understanding what happened, even after it was known in which tank the fission process occurred, has been considered an excellent illustration of the impracticability inherent in attempts to calculate criticality accident probabilities for specific processes.

### **(I-8) Idaho Chemical Processing Plant — October 17, 1978**

*(Solvent extraction process, enriched uranium)*

This accident occurred in a shielded cell of a fuel reprocessing plant where solutions from the dissolution of irradiated reactor fuel are processed by solvent extraction to remove fission products and recover the enriched uranium.

In the solvent extraction process, immiscible aqueous and organic streams counterflow with intimate contact and, through control of acidity, a material of interest was transferred from one stream to the other. In this operation, the aqueous recovery solution, containing less than 1-g enriched uranium per liter, was fed into the top of the column; less dense organic (a mixture of tributyl phosphate and kerosene) was fed into the bottom of the column (Fig. 7). A string of perforated plates along the axis of the column was driven up and down to form a 'pulsed column' and to increase the effectiveness of contact between the two streams. As the streams passed through the pulsed column, uranium was stripped from the aqueous stream by the organic. The large-diameter regions at the top and bottom of the column are disengagement sections where the aqueous and organic streams separate more completely (Fig. 8). The aqueous waste stream (raffinate) from the bottom of column 1A was sampled to verify compliance with

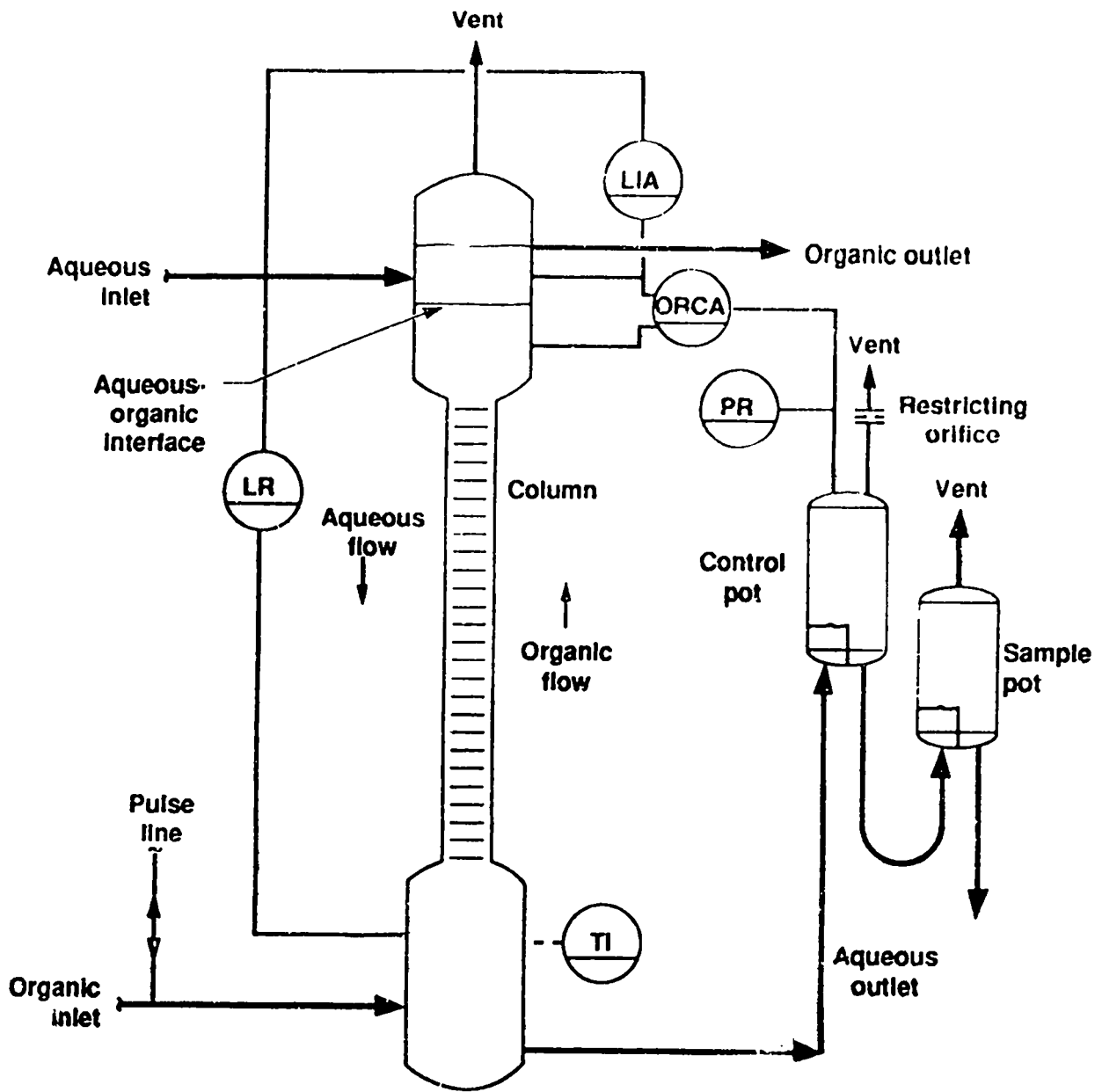

Figure 7. H-100 scrub column.

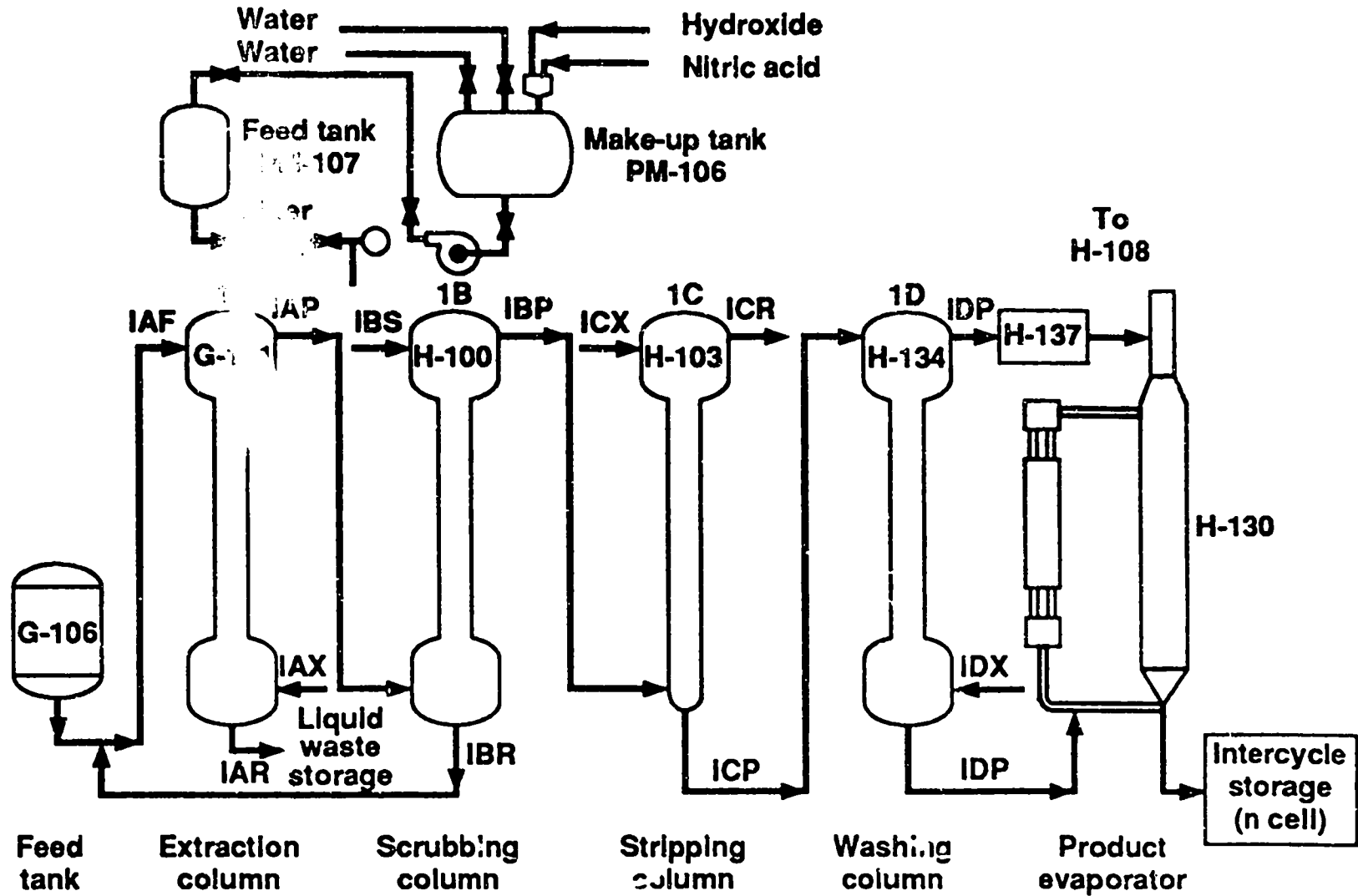

Figure 8. First-cycle extraction line, Idaho Chemical Processing Plant.

discard limits before being sent to waste storage tanks. The organic product stream (containing about 1-g U/l) from the top of column 1A was fed into stage two at the bottom of the pulsed scrubbing column, H-100 (1B).

In the second stage (1B), the organic product was contacted by a clean aqueous stream fed into the top of H-100 to scrub out residual fission products. The aqueous stream was buffered with aluminum nitrate to a concentration of 0.75M to prevent significant transfer of uranium from the organic stream to the aqueous stream. In normal operation, some uranium would be taken up by the aqueous, to a concentration of about 0.15 g/l, so the aqueous output of column 1B was fed back and blended with the dissolver product going into column 1A. The organic product stream stripping from 1B, normally about 0.9-g U/l, went on to stage three (1C), where the stripping column then went to mixer settlers where additional purification took place. Still further downstream, the uranium solution went to an evaporator where it was concentrated to permit efficient removal of the uranium.

Several factors contributed to this accident. An evaporator had plugged, and operations had been suspended for several weeks while instrumentation difficulties were corrected. During the downtime, a valve leaked water into the aluminum nitrate makeup (PM-106) tank used for preparation of the aqueous feed to the scrubbing stage (1B). This leak, over time, caused a dilution of the feed solution from 0.75M to 0.08M. The 13,400-l makeup tank was equipped with a density gauge that would have indicated the discrepancy, but the gauge was inoperable. A density gauge was scheduled to be installed on the 3,000-l process feed (PM-107) tank that was filled, as necessary, from the makeup tank, but this had not been done. The makeup tank was instrumented with a strip-chart recorder showing the solution level in the tank, but the leak into the tank was so slow that the change in level was not discernible without pulling out several days of chart length. Procedures required that the density in the process feed tank be obtained after each transfer from the makeup tank. Results of sample analyses were not available until after the accident.

The out-of-specification aqueous feed to the scrubbing column caused it to operate as a stripper rather than as a scrubber. Some of the enriched uranium was removed from the column 1B organic and recycled in a steady increase in the uranium inventory in the two columns. Each time diluted solution was added to the feed tank from the makeup tank, the aluminum concentration in the feed was further reduced and stripping became more effective until the excursion occurred.

Analyses of the aqueous feed for column 1B (feed tank PM-107-0) showed the proper concentration of 0.7M aluminum nitrate on September 15, 1978. Samples taken on September 27 and October 18 (the day after the accident) had concentrations of 0.47M and 0.084M, respectively. Concentrations of aluminum nitrate less than 0.5M are insufficient to prevent some stripping of uranium from the organic, and the final concentration would result in almost all of the uranium being stripped from the organic.

The process feed tank (PM-107-0) was filled with aluminum nitrate solution from the makeup tank (PM-106-0) at about 6:30 p.m., October 17. Approximately an hour and a half later, the process operator was having difficulty controlling pulsed scrubbing column H-100 (1B). During his efforts to maintain proper operation, he reduced the pressure on the control pot, thus permitting increased aqueous flow from H-100 back to G-111 (1A). At approximately 8:40 p.m., a radiation alarm activated, probably because of fission products in the plant stack gases. Shortly after the alarm, several other alarms activated and the stack monitor gave a full-scale reading. The shift supervisor and the health physicist went outside the building and detected radiation intensities up to 100 mrem/h. At

9:03 p.m., the shift supervisor ordered the building evacuated, and by 9:06, an orderly evacuation had been completed. Appropriate road blocks were established, and management was properly notified.

In the evacuation, the process operator shut off all feed to the first-cycle extraction process, but did not stop the pulsation of the columns.

The reaction clearly took place in the lower section of H-100, with most of the fissions occurring in the upper part of the section. Records indicate the reaction rate increased very slowly until late in the sequence, when a sharp rise in power occurred. The uranium inventory in column H-100 was estimated to have been about 10 kg, compared with slightly less than 1 kg during normal operation. The total number of fissions during the reaction was estimated to be  $2.7 \times 10^9$ , or an energy release of about 165 megajoules. The average power during the approximately one-half hour of the reaction was than a little less than 100 kW.

It is probable that, as the uranium inventory in the bottom of H-100 increased because of the lean aluminum nitrate scrub solution, the system achieved the delayed-critical state, then became slightly supercritical, and the increasing power raised the temperature to compensate for the presence of additional uranium. This process would continue as long as the uranium addition was slow and until the reduced pressure on the control pot permitted more rapid addition of uranium and a sharp increase in reactivity. The system is thought to have approached prompt criticality, at which time the rate of power increase would have been determined by the neutron lifetime that would be on the order of milliseconds. The continuation of the pulse action after the feed was turned off probably led to improved mixing of the solution in the bottom section of H-100 and terminated the reaction.

No significant personnel exposure and no damage to process equipment occurred. As a direct result of this event, the plant suffered an extended and expensive shutdown; all operating procedures were reviewed in detail and revised as appropriate. Increased emphasis was given to plant maintenance and operator training. An extensive and highly instrumented plant protection system involving redundant sensors and redundant, automatic safety controls was installed.

The importance of maintenance of safety-related equipment and the need for adherence to well-developed operating procedures were reemphasized by this accident.

## SUMMARY OF PROCESS ACCIDENTS

These process accidents were characterized by spike yields of limited size (about  $10^{17}$  to  $10^{18}$  fissions). Little or no damage occurred to process equipment. The availability of and prompt response to criticality accident alarm systems has resulted in saving lives of people more than a few meters from the reaction vessel. Facility downtime following an accident appeared to have depended on administrative decisions rather than on accident safety.

## PART II

### THREE EARLY CRITICAL EXPERIMENT ACCIDENTS

Los Alamos, New Mexico — June 6, 1945<sup>16</sup>

*(Pseudosphere of uranium cubes, water reflected, local control)*

The experiment was designed before the days of remote control and was intended to establish the critical mass of enriched uranium metal when it was surrounded by hydrogenous material. The uranium mass of 35.4 kilograms (average enrichment 79.2%) was stacked in the form of a pseudosphere constructed of 0.5-inch cubes and blocks 0.5 x 0.5 x 1 inch. The core was in a 6-inch cubical polyethylene box, with the void space filled with polyethylene blocks. The whole assembly was placed in a large tank that was then partially filled with water.

The assembly became critical (unexpectedly) before water had completely covered the polyethylene box. The situation was aggravated because no scram device was built into the system and the inlet and drain valves were 15-feet apart. Before the system was reduced to a safe subcritical state 5 or 10 seconds later, a total of 3 to 4 x 10<sup>16</sup> fissions were created, an energy release sufficient to raise the average temperature of the metal to more than 200 degrees Celsius. Subsequent examination of the polyethylene box showed that it was not watertight. It is probable that water seeped slowly into the uranium assembly as the level was being raised above the bottom of the box. The additional moderation then caused the supercritical situation which was terminated by boiling of the water within the box and next to the metal cubes.

Calculations by O. D. Thompson, formerly of the LANL Criticality Safety Staff have provided some insight into this accident. Nesting spherical shells of U(79.2), having a thickness of 8 mm and a total mass of 35.4 kg, were evaluated with gaps between the shells of 0.5- and 1-mm. Adding water to the gaps increased the multiplication factor (k) by 0.04 for the 1-mm gap, while for the 0.5-mm case this increase was found to be 0.02. These results apply to the assembly fully reflected by water, where the calculated multiplication factor was 1.024 and 1.018, respectively. The full-water reflector was found to be worth 0.21 in k. While the geometry of the calculations represents only a rough approximation of the actual assembly, refinements are probably not justified. Indications are that the uranium cubes were "as cast," so the actual volume available to the water cannot be known.

The characteristics of excursions of large masses of fissile metal in water are, at best, poorly known. A calculation by G. E. Hansen has shown that for a 0.86-cm-radius <sup>235</sup>U sphere in water, 15% of the fissions occur in the outer 0.05 cm, and the fission density in this region is six times that at the center. A spike of 3 x 10<sup>15</sup> fissions would then raise the temperature 130°C while the central regions would remain relatively cool with a temperature rise of only 19°C. The initial spike must have been of this order of magnitude, with the majority of the fissions following at a much lower average power.



**Los Alamos, New Mexico — August 21, 1945<sup>18,21</sup>**

*(Plutonium core reflected with tungsten carbide, hand assembly)*

**Los Alamos, New Mexico — May 21, 1946<sup>13,21</sup>**

*(Plutonium core reflected with beryllium, hand assembly)*

These two accidental excursions occurred with the same core and were, in several respects, quite similar. The core consisted of two hemispheres of delta-phase plutonium coated with 5 mils (0.005 inches) of nickel. The total core mass was 6.2-kg, and the density was about 15.7 g/cc.

In the first accident, a critical assembly was being created by hand stacking 4.4-kg tungsten carbide bricks around the plutonium core. Figure 9 shows a re-enactment of the configuration with about half the tungsten blocks in place. The lone experimenter had almost completed the stack and was moving the final block over the assembly for a total reflector mass of 236 kg when he noticed from the nearby neutron counters that the addition of this brick would make the assembly supercritical. As he withdrew his hand, the brick slipped and fell onto the center of the assembly, adding sufficient reflection to make the system super-prompt critical, and a power excursion occurred. He quickly pushed off the final brick and proceeded to unstack the assembly. His exposure was estimated at 510 rem from a yield of  $10^{16}$  fissions.

An Army guard assigned to the building, but not helping with the experiment, was irradiated in the amount of approximately 50 rem. The nickel cladding on the plutonium core did not rupture.

In the second accident, the techniques involved in creating a metal critical assembly were being demonstrated to several people. The system consisted of the same plutonium core, reflected in this case by beryllium. The top and final hemispherical beryllium shell was being lowered slowly into place; one edge was touching the lower beryllium hemisphere, while the opposite edge was resting on the tip of a screwdriver (Fig. 9). The person conducting the demonstration was holding the top shell with his left thumb placed in an opening at the polar point, while slowly working the screwdriver out with his right hand. At this time the screwdriver slipped from under the shell and the shell seated on the lower hemisphere. An excursion occurred at once, the shell was thrown to the floor, and all personnel left the room. The yield of this excursion was  $3 \times 10^{15}$  fissions, and again there was no rupture of the nickel cladding. The eight people in the room were irradiated in the amounts of 2100, 360, 250, 160, 110, 65, 47 and 37 rem. The man who performed the experiment died 9 days later as a result of radiation injury.

The results of calculation of the fission rate in this sphere as a function of time for several values of excess reactivity are shown in Fig. 11. Fig. 12 represents the total number of fissions to be expected as a function of time for these same excess reactivities. These calculations were performed by T. P. McLaughlin of the Los Alamos National Laboratory.

These data are applicable to both accidents because the difference in reflector material had only a small effect on the neutron kinetics. In the first experiment, if the excess reactivity did not exceed 0.15\$, the assembly must have been together for several seconds, which is not unreasonable. In the second event, the experimenter was better prepared to disassemble the material, and it is thought that this was done in a fraction of a second, and perhaps less than 0.5 second.

The known parameters would then be satisfied by an excess reactivity of about 0.10\$.

The second of these plutonium sphere accidents convinced people that hand-stacking fissionable material in critical or near-critical configurations entailed unacceptable risks. A remote critical assembly facility was built at the same Los Alamos site (TA-18, called Pajarito Site) where this accident occurred and is still in use. To date, Pajarito Site has conducted many thousands of approaches to criticality with no injuries caused by nuclear excursions, and only minor equipment damage from the approximately ten excursions that have occurred. In fact, this site has amassed a record of about 40 years without a lost-time accident.

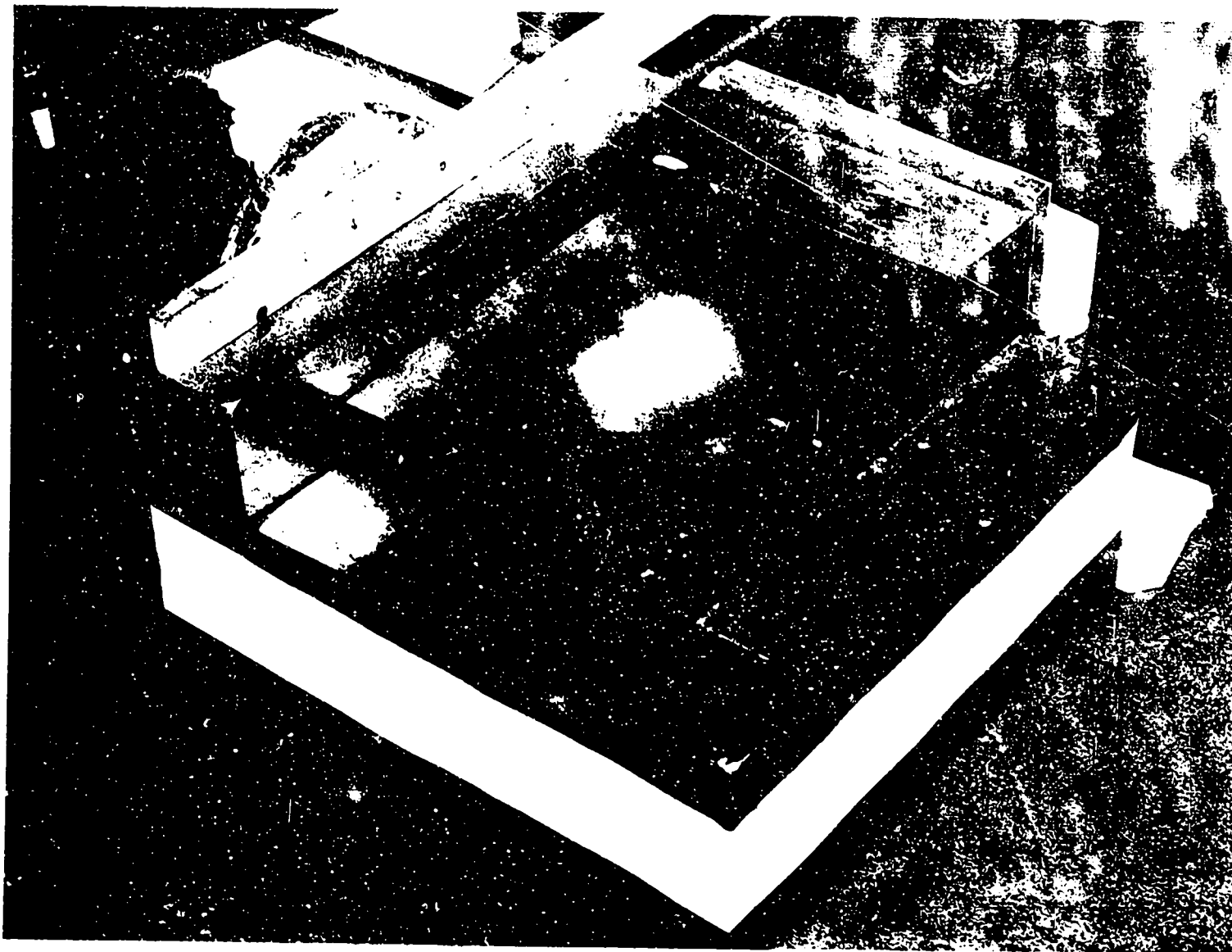

**Figure 9.** Plutonium sphere partially reflected by tungsten carbide blocks.

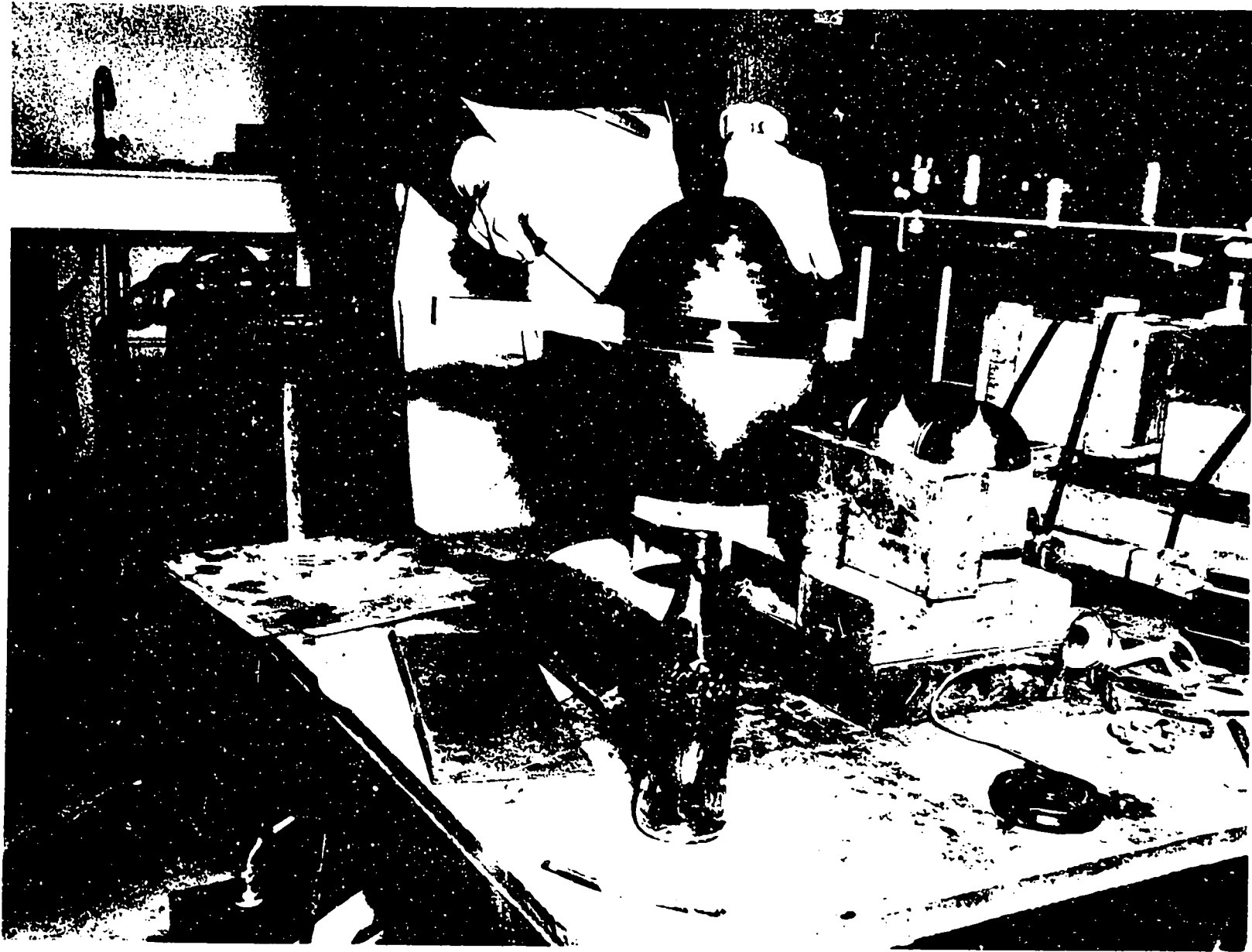

**Figure 10.** Configuration of beryllium reflector shells prior to the accident of May 21, 1946.

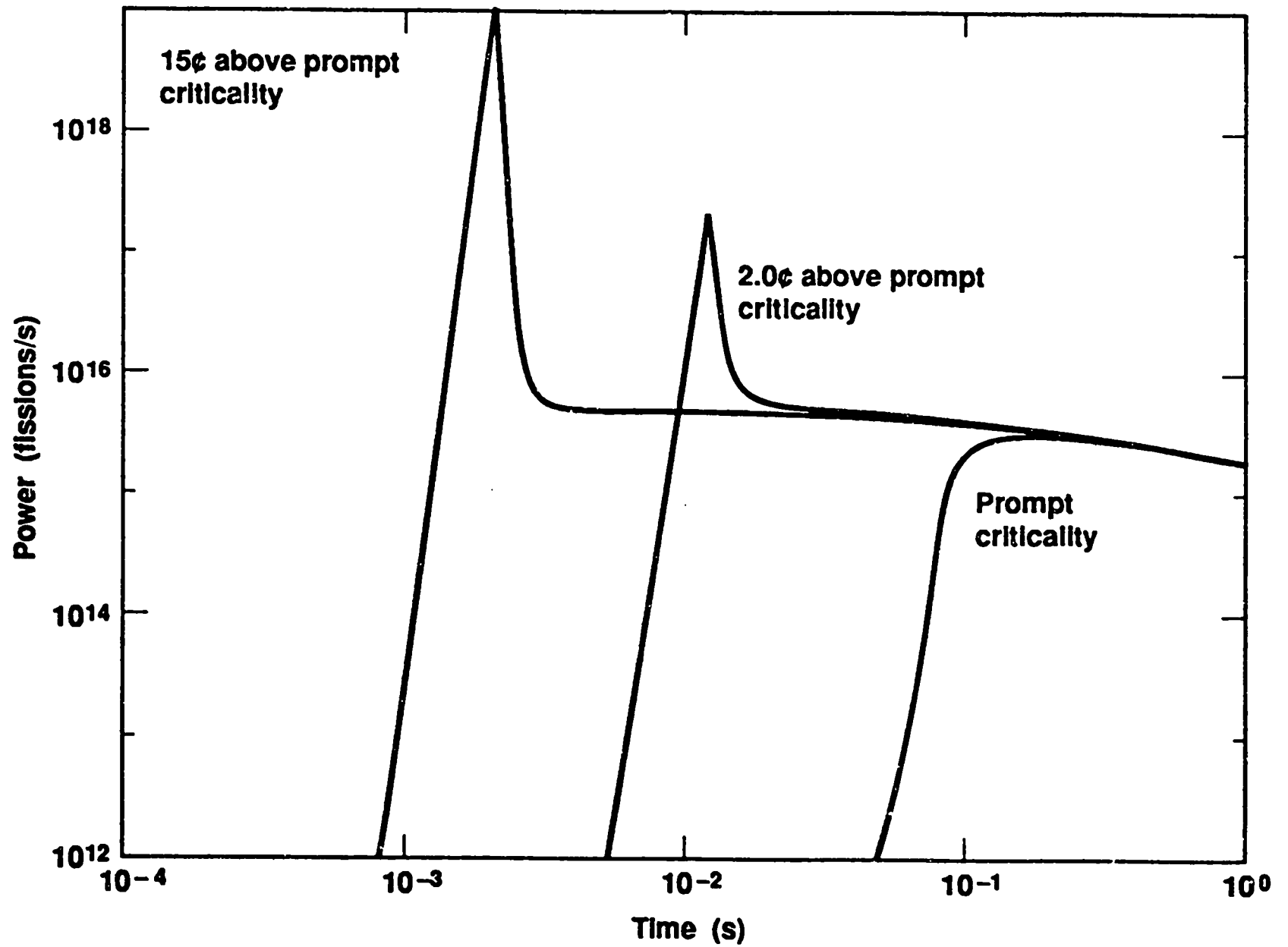
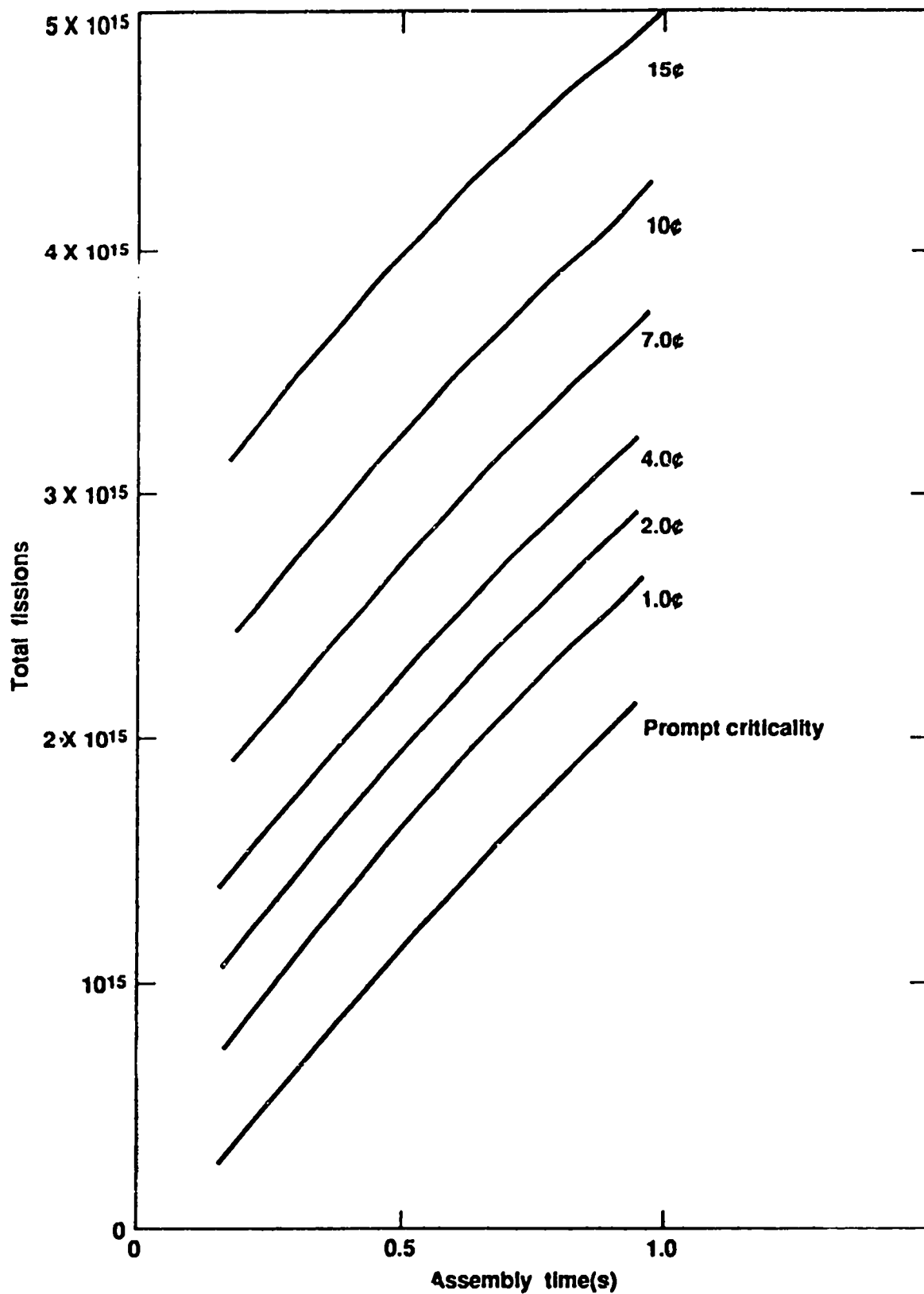

Figure 11. Calculated fission rate for the 6.2-kilogram plutonium sphere.



**Figure 12. Calculated total fissions vs. time for the 6.2-kilogram plutonium sphere.**

## REFERENCES

2. *Accidental Radiation Excursion at the Y-12 Plant June 6, 1958*, Union Carbide Nuclear Company, Y-12 Plant, Oak Ridge, Tennessee, Y-1234, (1958).
3. Callihan, D., and J. T. Thomas, "Accidental Radiation Excursion at the Oak Ridge Y-12 Plant—1, Description and Physics of the Accident," *Health Phys.*, **1**, 363-372, (1959).
4. "Oak Ridge Y-12 Accidental Excursion, June 6, 1958," *Nucleonics*, **16**, Nov., 138-140, 200-203 (1958).
5. Paxton, H. C., R. D. Baker, W. J. Maraman, and R. Reider, *Nuclear-Critical Accident at the Los Alamos Scientific Laboratory on December 30, 1958*, Los Alamos Scientific Laboratory, Los Alamos, New Mexico, LAMS-2293 (1959).
6. Paxton, H. C., R. D. Baker, W. J. Maraman, and R. Reider, "Los Alamos Criticality Accident, December 30, 1958," *Nucleonics*, **17** (4) 107-108, 151 (1959).
7. Ginkel, W. L., C. W. Bills, A. O. Dodd, K. K. Kennedy, and F. H. Tingey, *Nuclear Incident at the Idaho Chemical Processing Plant on October 16, 1959*, Phillips Petroleum Company, Atomic Energy Division, Idaho Falls, Idaho, IDO-10035, (1960).
8. Paulus, P. C., A. O. Dodd, K. K. Kennedy, F. H. Tingey, and F. M. Warzel, *Nuclear Incident at the Idaho Chemical Processing Plant on January 25, 1961*, Phillips Petroleum Company, Atomic Energy Division, Idaho Falls, Idaho, IDO-10036 (1961).
9. Callihan, D., "Accidental Nuclear Excursion in Recuplex Operation at Hanford in April 1962," *Nucl. Safety*, **4** (4), 136 (1962).
10. Clayton, E. D., *Further Considerations of Criticality in Recuplex and Possible Shutdown Mechanism*, Hanford Atomic Products Operation, Hanford, Washington, HW-77780 (1963).
11. Zangar, C. N., *Summary Report of Accidental Nuclear Excursion Recuplex Operation 234-5 Facility*, HW74723, Richland Operations Office, AEC, TID-18431 (1962).
12. Nakache, F. R., and M. M. Shapiro, *The Nuclear Aspects of the Accidental Criticality at Wood River Junction, Rhode Island, July 24, 1964*, Supplemental Report, United Nuclear Corporation, New Haven, Connecticut, Fuels Division, TID-21995 (1964).
13. Kouts, H., et al., Report of the AEC Technical Review Committee, November 6, 1964.
14. Daniels, J. T., H. Howells, and T. G. Hughes, "Criticality Incident—August 24, 1970, Windscale Works," *Trans. Am. Nuc. Soc.*, **14**, 35-36 (1971).

15. Evans, M. C., "A Review of Accidents Within the European Community," *Trans. Am. Nuc. Soc.*, **46**, 462-462 (1984).
16. Hayes, D. F., *A Summary of Accidents and Incidents Involving Radiation in Atomic Energy Activities, June 1945 through December 1955*, U. S. Atomic Energy Commission, TID-5360 (1956).
21. Paxton, H. C., *Booby Traps*, Los Alamos Scientific Laboratory, Los Alamos, New Mexico, AECD-4240, (1957).



# **PROCESS CRITICALITY ACCIDENT LIKELIHOODS, CONSEQUENCES, AND EMERGENCY PLANNING\*\***

Thomas P. McLaughlin

## **ABSTRACT**

Evaluation of criticality accident risks in the processing of significant quantities of fissile materials is both complex and subjective, largely due to the lack of accident statistics. Thus, complying with standards such as ISO 7753, which mandates that the need for an alarm system be evaluated, is also subjective. A review of guidance found in the literature on potential accident magnitudes is presented for different material forms and arrangements. Reasoned arguments are also presented concerning accident prevention and accident likelihoods for these material forms and arrangements.

## **INTRODUCTION**

General guidance for emergency planning for facilities and operations involving significant quantities of fissile materials is contained in various regulations and consensus standards. In particular, American National Standard ANSI/ANS-8.3, "Criticality Accident Alarm Systems," and its international counterpart, ISO 7753 "Nuclear Energy — Performance and Testing Requirements for Criticality Detection and Alarm Systems," mandate that the need for an alarm system be evaluated and that one be made operational when it is deemed that it will reduce overall risk. This mandate considers only a risk/risk evaluation, with no guidance provided as to cost/risk or cost/benefit considerations.

Since risk is a combination of likelihood and consequence, both aspects must be considered, yet each is extremely difficult to quantify in most process situations. Concerning likelihoods, it is noted that only eight process accidents have been reported in the 45 years that minimum critical quantities of fissile material have been available.<sup>1</sup> All eight involved solutions, and only one occurred in a volume greater than 200 liters. Clearly, these meager accident statistics only highlight the obvious — criticality accidents with fissile solutions are very unlikely, and ones involving nonsolution forms are much less likely still.

Probabilistic risk assessment (PRA) has been recognized as a possible avenue to determine likelihoods, but drawbacks have been recognized, notably in "hands on" operations where failure-rate data is uncertain. Additionally, it is argued that the large sums that would be spent (an estimate for the Los Alamos Plutonium Facility is a few million dollars) could be better used on control measures such as

---

\*\* From Los Alamos National Laboratory report LA-UR-91-2325, July 1991 and "Proceedings of the International Conference on Nuclear Criticality Safety," September 1991, Vol. 2, p. VII-1.

more criticality staff presence on the process floor. A recent "test" PRA on only one of hundreds of operations in the Los Alamos facility cost about \$20,000, exclusive of the value of the time operating personnel and criticality staff spent working with the PRA contractor.<sup>2</sup>

The author finds it noteworthy, in regards to the application of PRA, that in one of the eight accidents (Windscale), after it was determined in which vessel the accident had occurred, experts were still unable to ascertain the accident mechanism.

The consequences of criticality accidents are a function of several factors: whether or not the operation is "hands on" or in a shielded facility; the magnitude of the excursion; and, emergency actions. The last two factors will be discussed in detail in the remainder of this paper, where it is also argued that with reasonable controls on operations, accidents with metals and dry compounds should be able to be made so unlikely as to be considered incredible.

Magnitudes of criticality accidents are the subject of much controversy and misunderstanding. For example, the 1985 Los Alamos report, "A Guide to Radiological Accident Considerations for Siting and Design of DOE Nonreactor Nuclear Facilities" contains a brief section entitled Criticality Accidents.<sup>3</sup> In this section, a table of fission yields from accidents with different material forms is presented. This table was reproduced from Woodcock and is included here as Table 1.<sup>4</sup> The Nuclear Regulatory Commission also issues guidance on the magnitude of criticality accidents.<sup>5,6</sup> It is noted in these NRC documents that predicting fission yields in some heterogeneous and nonsolution systems such as described in Table 1 "results in a broad range of possible yields" and "methods for estimating possible fission yields are less reliable." The NRC also recommends that credible accidents be assessed for potential magnitude on an individual case basis.

In the body of this paper, we discuss each of the material forms indicated in Table 1, the appropriateness of the fission yield values, and, particularly for non-solution systems, reasons why effort might be better spent in controlling the accident likelihood at a vanishingly low level than attempting to quantify its likelihood and consequences.

**TABLE 1 - Criticality Accident Fission Yields\***

| System   | Initial Burst Yield<br>(fissions) | Total Yield<br>(fissions) |
|--|-----------------------------------|---------------------------|
| Solutions under 100 gal.(0.46-m <sup>3</sup> )               | 1 x 10 <sup>17</sup>              | 3 x 10 <sup>18</sup>      |
| Solutions over 100-gal.(0.46-m <sup>3</sup> )                | 1 x 10 <sup>18</sup>              | 3 x 10 <sup>19</sup>      |
| Liquid / powder <sup>b</sup>                                 | 3 x 10 <sup>30</sup>              | 3 x 10 <sup>30</sup>      |
| Liquid / metal pieces <sup>c</sup>                           | 3 x 10 <sup>18</sup>              | 1 x 10 <sup>19</sup>      |
| Solid uranium  | 3 x 10 <sup>19</sup>              | 3 x 10 <sup>19</sup>      |
| Solid plutonium  | 1 x 10 <sup>18</sup>              | 1 x 10 <sup>18</sup>      |
| Large storage arrays <sup>d</sup><br>(below prompt critical) | None                              | 1 x 10 <sup>19</sup>      |
| Large storage arrays <sup>d</sup><br>(above prompt critical) | 3 x 10 <sup>22</sup>              | 3 x 10 <sup>22</sup>      |

\* Based on a similar table by Woodcock (1966).

<sup>b</sup> A system where agitation of a powder layer could result in progressively higher reactivity insertion.

<sup>c</sup> A system of small pieces of fissile material.

<sup>d</sup> Large storage arrays in which many pieces of fissile material are present and could conceivably come together.

## SOLUTIONS

Significantly, although not surprisingly, all eight of the reported process criticality accidents involved material in solution as opposed to dry materials or mixtures of metal/powders and water. There are several reasons:

- (1) solutions have much smaller critical masses than dry materials and, indeed, all eight of the process accidents, while not in optimum geometries or concentrations, occurred with much less than minimum critical masses for unmoderated materials;
- (2) dry powders and accumulations of small metal pieces such as cutting chips from a machining operation, which (if immersed) may have small critical masses similar to solution values, have additional lines of defense that should be formidable — they are usually processed in moderation-controlled environments and/or in small vessels of favorable geometry;
- (3) loss of configuration control, that is, the controls that prevent fissile material from accidentally achieving a more reactive state than operating procedures provide, has led to all eight accidents.

Simply put, material moved or was moved from favorable geometry vessels to unfavorable geometry vessels due to combinations of design oversight, operator error, and equipment failures. Clearly, similar inadvertent movement of dry materials is much less likely as should be the inadvertent loss of moderation control if it has been identified as a major line of defense in accident prevention.

A recent analysis for a design-basis solution criticality accident at the Oak Ridge Y-12 Plant<sup>7</sup> exemplifies the benefits of a situation-specific review:

- (1) one has a reasonably firm basis for emergency planning;
- (2) other simplified methods, such as offered by Tuck,<sup>8</sup> may not be appropriate for potential upset conditions considered credible;
- (3) single values such as offered by the NRC guides or by Woodcock (Table 1), provide no insight into what may actually lead to an accident situation and may be either significantly under or over conservative for emergency planning purposes.

The Y-12 analysis used CRAC solution excursion data to provide confidence in the upper limit of the first spike fission yield of a solution criticality accident.<sup>9</sup> This approach may be applied even more readily to plutonium solution systems where one is confident that there is no significant wait-time associated with the initiation of the first persistent fission chain after the prompt critical state is reached.

The potential for subsequent fission bursts and for eventual quasi-steady state solution boiling near the delayed critical point is also recognized. While it may be difficult to assess the likelihood of permanent shutdown after the first fission spike when performing analyses for safety documentation, more importantly, the case may be made that subsequent fission bursts and even significant additional fissions beyond the first burst are not a serious threat.

The CRAC data demonstrate that even with the continual introduction of fissile solution into a system that has just undergone a fission burst, subsequent spikes are delayed several seconds or more. Secondly, any additional bursts will likely be reduced in intensity by a factor of 5 or 10 from that of the initial burst. The power and energy histories for one of the (typical) CRAC excursions shown in Figure 1 illustrate both the time delay and lower magnitude associated with subsequent bursts.

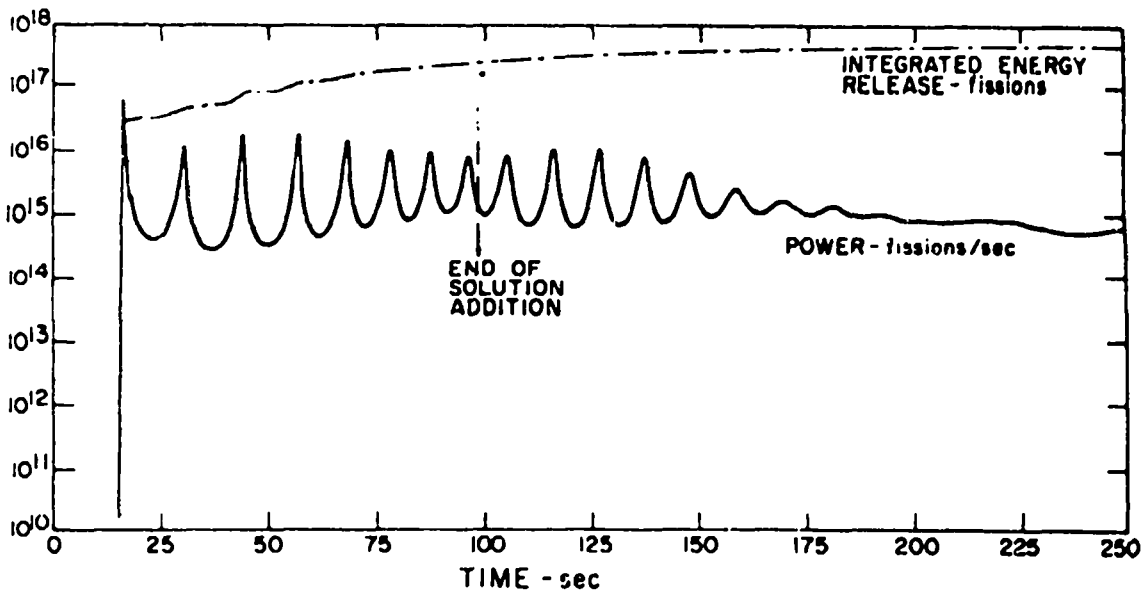

**Figure 1 — Fission rate and integrated fission energy release in CRAC 19 as a function of time**

These two observations have important implications on emergency planning:

- (1) The time delay of several seconds between bursts provides anyone in the immediate vicinity of the initial burst ample time to remove themselves significantly further by the time of the second burst. This is a major justification for a criticality accident alarm system.
- (2) For those not immediately threatened by exposure to direct radiation from the first burst, a combination of evacuation routes and (expected) reduced yields of subsequent spikes should assure that no life-threatening dose is received during facility evacuation. Once personnel are sufficiently distant such that direct doses are not a concern (and this should be verified at any muster location), then one can monitor for fission product radiation levels and move personnel as appropriate to prevent further exposures. It is noteworthy that fission product doses have not led to life-threatening exposures even though yields in some of the eight accidents exceeded the initial burst yield by more than two orders of magnitude.

In summary, one can conclude with reasonable confidence that if prompt evacuation proceeds via appropriate routes, then significant, direct doses should be limited largely to those resulting from the initial burst. Finally, if the reaction is not shut down after the first burst, then area monitoring should enable the prevention of significant exposures from persistent, low-level direct doses or from fission product radiation.

## Liquid/Powder

The scenario that led to the  $3 \times 10^{20}$  value in Woodcock's report (Table 1) is one whereby autocatalytic phenomena are acting. In particular, he describes a situation in which dry powder becomes flooded, goes prompt critical as an equivalent very rich solution, and then the mixing and dilution that accompany the excursion introduces additional reactivity because one is sliding down the critical mass versus concentration curve. Woodcock acknowledges that there are competing feedback effects, the positive one already postulated, and the known negative effects of thermal expansion and microbubble formation. Finally, he states, "This estimate is rather a shot in the dark."

Stratton also alludes to the possibility of positive feedback as rich solution becomes diluted. However, he states, "it is difficult to imagine an explosive reaction." Clearly, then, he does not give credence to the  $3 \times 10^{20}$  value because in a few hundred liters or less, it would lead to an extraordinary explosion.

Perhaps the Woodriver Junction criticality accident came as close to matching Woodcock's scenario as any experimental evidence existing. Here 11 l of 240-g  $^{235}\text{U}$  solution was poured into a large vessel containing about 40-l sodium carbonate reagent. A fission burst occurred near the end of the pouring process; it had about  $10^{17}$  fissions, a specific yield of about  $5 \times 10^{15}$  fissions/liter. This specific yield is within the range of the CRAC data-specific yields and thus does not show a discernable autocatalytic yield augmentation as the fissile solution diluted in the sodium carbonate solution.

If process-specific reviews by criticality specialists ever reveal any scenarios leading to unacceptable consequences, then controls must be exercised that reduce the likelihood to a vanishingly small value, that is, an acceptable risk level.

## Liquid/Metal Pieces

Woodcock does not include any discussion of the bases for the fission yields of  $3 \times 10^{18}$  and  $1 \times 10^{19}$  in his report. It should be noted, however, that he is not referring to the "system of small pieces of fissile metal," which footnote c of Table 1 indicates, but instead, "the yields for metals or solids in water refer to one or a small number of pieces." This situation should be easily controllable and indeed may be incredible in most operations. It would be extremely rare that a water-flooded and/or water-reflected critical mass would be assembled as a single, dry unit. Were this necessary, certainly additional precautions to preclude the possibility of flooding/reflection would be taken. For a few large pieces, one would certainly provide spacing controls to assure generous safety margins. Solid material in storage would generally be in containers such that the container volume provides approximately one liter per kilogram of stored material. This assures that no accumulation of a small number of pieces, dry or in any admixture of water, will pose any credible criticality concerns.

## Solid Uranium and Solid Plutonium

Criticality accidents with solid metal systems (including alloys) should be readily controlled at a likelihood of occurrence that is vanishingly small. It is

almost inconceivable that masses approaching the bare critical sphere values would be handled in any compact form, either as a single unit or an accumulation of pieces such as in a burst reactor configuration. Only rarely are there operational requirements that necessitate working with more than the water-reflected spherical critical mass addressed in the previous section.

However, the criticality safety specialist has long recognized the potential for extreme consequences if an unmoderated, metal criticality accident were to occur.<sup>10</sup> As Table 1 illustrates, the possible magnitudes are greater for uranium than plutonium (all else being the same) because of the statistical nature of fission chain initiation in the presence of a weak source.

A manifestation of this recognition of potentially large fission yields with uranium metal is the large casting facility at the Y-12 plant.<sup>11</sup> This shielded facility has a built-in neutron source to minimize both yields and consequences of extremely unlikely accidents.

It should be emphasized that in spite of the shielding, it is the effort put into accident prevention and yield mitigation that is most important. If the consequences are unacceptable, then the accident likelihood must not be credible.

### **Large Storage Arrays**

Normal operations involving storage of fissile materials should be in compliance with appropriate federal requirements and consensus standards such as DOE Order 5480.5 and ANS-8.7. The storage arrays can be expected to have sufficient margins of subcriticality to compensate for credible normal and abnormal contingencies. A typical arrangement should be expected to result in a maximum neutron multiplication factor not exceeding about 0.9 for all evaluated credible contingencies. Further, it is required that no single mishap, misoperation, or violation of procedure lead to nuclear criticality.

The additional mass necessary to achieve prompt criticality with a single unit is between 1% and 3% of its critical mass, depending on whether the material is plutonium or uranium. The same can be said of an array at critical. However, the relation between the reactivity change to a unit in the array and the array reactivity is such that the 1-3% change in mass must be uniform throughout the array; i.e., to increase the array reactivity by an amount  $\Delta k$ , each unit in the array must be increased by this same  $\Delta k$ .

An equivalent reactivity addition to the array may be also affected by increasing the number of storage units or by reducing the volume of the storage container or of the storage cell volume in the array. In either of these cases, there is a dependence on the neutronic coupling between the units of the array. At critical, low-mass units will be strongly coupled, while large-mass units will be weakly coupled, a condition that also subsists in the subcritical state.

For example, to change the  $k_{eff}$  (for uranium units) from the critical state to a value of 1.01 would require a uniform change in excess of 3% in the mass of the units in the array, or a 5-7% uniform reduction in the volume of the array, or a 7-13% increase in the number of units in the array. The mass increment required is independent of the neutronic coupling, and the ranges given for the volume and

number of units correspond to progressing from strong to weak neutron coupling. These values are about the minimum to produce the prompt-critical state for enriched uranium

An accident during operation in a facility, however, can be expected to be initiated from the subcritical state. If the sequence of events leading to delayed criticality in a storage array were to begin at a nominal  $k_{eff}$  of 0.9, then the above required changes become a uniform mass augmentation of 37%, a uniform array volume reduction ranging from 44-53%, and an increase ranging from 262-377% in the number of units.

The implications of these results are that the accidental achievement of the critical state throughout a storage array caused by successive violations of administrative controls has a very low probability of occurrence, and prompt criticality is impossible, given the time required to effect the necessary changes.

The achievement of the critical or prompt-critical state in a single storage location would have to be considered or interpreted as array criticality. However, the contribution to the fission yield of the event by the array reactivity contribution among the units of an array is a function of the margin of subcriticality of the units.<sup>12</sup> An increase in the reactivity of a single unit in an array by an amount  $\Delta k$ , leads to a reactivity increase of about  $\Delta k/N$  to the array, where  $N$  is the total number of units in the storage array. This is typically a value of magnitude about that of the uncertainty associated with the array  $k_{eff}$ .<sup>13</sup> The total yield may even be less than would occur were the overloading of mass accomplished outside a storage area. Because the neutron background is higher than normal in storage areas, an earlier than usual initiation of the fission chain is likely.

For extreme upset conditions such as vault flooding or material collecting on the floor during an earthquake, simple, common-sense storage practices and a case-specific analysis should lead to the conclusion that either the critical state cannot credibly be reached or, if the upset condition is so severe that criticality cannot be precluded, then consequences of the criticality accident are minor compared to the total accident consequences. Under no circumstances can an accidental scenario be envisioned that would incorporate the simultaneity, speed, and neutron source requirements that would lead to anything approaching the "3x10<sup>22</sup> fissions" and "serious explosion" Woodcock proposes.

A fundamental storage practice for unmoderated fissile materials should be a maximum effective density, i.e., the fissile mass divided by the outer container volume, which does not exceed about 1.0 kg/l. For such a simple storage practice, it can be readily shown that even relatively large, compact accumulations of containers (such as are often postulated to be associated with earthquakes) remain subcritical.

## SUMMARY

While most regulatory guidance and, indeed, common sense, dictates that criticality accident risks be evaluated, both the likelihood and the consequence components of this risk are difficult to quantify. However, this risk evaluation is necessary input into decisions relating to criticality accident emergency planning, including alarm systems.



Several points relating to these likelihood and consequence issues are argued in this paper:

- A case-specific analysis should be performed rather than adopting simplistic fission yield values such as presented in Table 1.
- Fissile material processes and storage involving dry materials should, in general, be much more readily controlled than those involving solutions.
- Efforts expended on emergency planning for criticality accidents postulated to occur with dry materials might be better spent on reducing accident likelihoods by providing more effective design and oversight of process operations, and improved operator and supervisor knowledge and awareness.
- For large-scale fissile solution processing, accident likelihoods, while not readily quantified, will generally not be able to be reduced to the "incredible" level. That is, it is generally agreed that for such operations emergency planning is cost- and risk-effective. However, the CRAC data coupled with site-specific evaluations, provide sufficient information to enable emergency planning to be based on realistic fission yield estimates.

In summary, accident experience, CRAC data, and case-specific evaluations, coupled with appropriate emergency planning, should provide confidence that criticality accidents are local events with insignificant off-site consequence. Postulated accidents with large fission yields such as indicated in Table 1 must be controlled so that likelihoods are so remote as to be considered incredible and thus the risks are acceptable.

## REFERENCES

1. D. R. Smith, "A Review of Criticality Accidents," Nuclear Criticality Information System report DOE/NCT-4 (1989).
2. R. R. Jackson, and W. A. Melody, "Nuclear Criticality Accident Analysis (TA-55, PF-4)," SAIC-89/1590 (1989).
3. J. C. Elder, J. M. Graf, J. M. Dewart, T. E. Buhl, W. J. Wenzel, L. J. Walker, and A. K. Stoker, "A Guide to Radiological Accident Considerations for Siting and Design of DOE Nonreactor Nuclear Facilities," Los Alamos National Laboratory report LA-10294-MS (January 1986).
4. E. R. Woodcock, "Potential Magnitude of Criticality Accidents," United Kingdom Atomic Energy Authority Report AHSB (RP)R-14 (1966).
5. U. S. Nuclear Regulatory Commission, Regulatory Guide 3.34, Revision 1, July 1979, "Assumptions Used for Evaluating the Potential Radiological Consequences of Accidental Nuclear Criticality in a Uranium Fuel Fabrication Plant."

6. U. S. Nuclear Regulatory Commission, Regulatory Guide 3.35, Revision 1, July 1979, "Assumptions used for Evaluating the Potential Radiological Consequences of Accidental Nuclear Criticality in a Plutonium Processing and Fuel Fabrication Plant."
7. W. T. Mee, D. A. Reed, and R. G. Taylor, "Consequences of a Postulated, Moderated Criticality Accident at the Oak Ridge Y-12 Plant," Oak Ridge Y-12 Plant report Y/DD-384 (September 1988).
8. G. Tuck, "Simplified Methods of Estimating the Results of Accidental Solution Excursions," *Nuclear Technology*, Vol. 23, August, 1974.
9. P. Lecorche and R. L. Seale, "A Review of the Experiments Performed to Determine the Radiological Consequences of a Criticality Accident," Y-CDC-12, UC-46 - Criticality Studies (November 1973).
10. H. C. Paxton, "The Nature and Consequences of Nuclear Accidents," in "Proceedings from The National Topical Meeting on Nuclear Criticality Safety," (Las Vegas, NV, 1966).
11. W. T. Mee and E. C. Crume, "Protective Features of a Facility for Large U235 Castings," in "Proceedings from The National Topical Meeting on Nuclear Criticality Safety," (Las Vegas, NV, 1966).
12. R. Avery, "Theory of Coupled Reactors," in "Proceedings of the Second International Conference of the Peaceful Uses of Atomic Energy," (Geneva, 1958).
13. G. E. Whitesides, *ANS Trans.*, Vol. 14, p. 680, 1971.

# **APPLICATIONS OF PRA IN NUCLEAR CRITICALITY SAFETY\*\*\***

Thomas P. McLaughlin

## **INTRODUCTION**

Traditionally, criticality accident prevention at Los Alamos has been based on a thorough review and understanding of proposed operations or changes to operations, involving both process supervision and criticality safety staff. The outcome of this communication was usually an agreement, based on professional judgment, that certain accident sequences were credible and had to be reduced in likelihood either by administrative controls or by equipment design, and others that were not credible and thus did not warrant expenditures to further reduce their likelihood. The extent of analysis and documentation was generally in proportion to the complexity of the operation, but did not include quantified risk assessments.

During the last three years, nuclear criticality safety-related Probabilistic Risk Assessments (PRAs) have been performed on operations in two Los Alamos facilities. Both were conducted to better understand the cost/benefit aspects of PRA's as they apply to largely "hands-on" operations with fissile material for which human errors or equipment failures significant to criticality safety are both rare and unique. Based on these two applications and an appreciation of the historical criticality accident record (frequency and consequences), it is apparent that quantified risk assessments should be performed selectively.

Several factors are relevant in this regard: cost; process and criticality staff time diverted from conventional risk management methods; the tendency to be content below some quantified risk level and not strive for continuing oversight and improvement; the high rate of change of processes in an R&D facility; the subjectivity in assigning likelihoods where data is scarce.

A fundamental philosophical difference also exists between conventional risk control and the application of PRAs in nuclear criticality safety. Traditionally, processes have been analyzed and evaluated to be subcritical for process upsets judged to be credible; the evaluation was not extended to the critical point. A PRA evaluates scenarios that are taken to the critical point; this involves significantly more analysis effort.

---

\*\*\* From Los Alamos National Laboratory report LA-UR-92-1892, June 1992 and *ANS Trans*, Vol. 65, p. 546.

## METHODOLOGY

Outside PRA experts were employed for these studies, with criticality safety and process operations expertise provided by Los Alamos personnel. From the outset, PRA personnel recognized that absolute frequency estimates for the occurrence of a criticality accident would be difficult to evaluate with either accuracy or precision. As with many quantified risk assessment exercises, the assessment process was seen to be more valuable than any single numerical result. That is, the goal was to provide confidence that there were no unforeseen weak links in the chain of events that could lead to an accident.

The first application, for the plutonium facility, was completed and written up as a separate document as well as incorporated into the updated Safety Analysis Report for this facility.<sup>1</sup> The plutonium facility has literally hundreds of different in-glove-box and out-of-glove-box operations involving fissile masses in excess of minimum quantities required for criticality. After recognizing the obvious vast differences in criticality accident likelihoods among these operations, it was decided to perform a PRA on a single operation representative of one judged to have a higher criticality accident likelihood relative to other operations. A first, coarse screening was based on a review of all operations by broad categories such as solution processing, reactor-fuel fabrication, metal casting and machining, and powder operations. Integral to this screening were extensive discussions and document reviews between the PRA experts and the Los Alamos Criticality Safety Staff, reaching an understanding and appreciation of relative accident likelihoods and consequences for these different categories of operations.<sup>2</sup> A review of criticality accident experience was also an important aspect of this screening.<sup>3</sup>

Only eight process criticality accidents have been reported, six between 1958 and 1964, one in 1970, and one in 1978. All of these included fissile material in solutions and all but one (1970 Windscale, U.K.) were in the U. S. The approximately one accident per year in the 1958-1964 time span stimulated increased attention to nuclear criticality safety and brought into existence criticality safety staff in all the major fissile material processing organizations in the U. S. Since that time, the two subsequent accidents have occurred at a rate of roughly one per ten years, an order of magnitude improvement. It is reasonable to expect this improved record to be applicable to future operations so long as management maintains its commitment to safe operations and a dedicated and conscientious criticality staff is permitted to contribute to the safety of these operations. The eight process accidents that have occurred resulted in two fatalities and less than two dozen significant radiation exposures. Any major revision in the responsibilities or methods of operation of the criticality safety staff should be given great consideration.

It seems particularly relevant that subsequent to one of these eight accidents, even after the vessel in which the fission reaction occurred had been identified, no explanation or mechanism for the accident was recognized. Clearly the probability of such an accident could not be calculated in advance.

A second screening focused on solution processing areas, in particular highlighting those operations with large solution volumes, large fissile masses, and large process vessels or receptacles for solution subsequent to process upsets. The result of this review was the conclusion that any of several processes that generally met the above criteria would be appropriate candidates. Based on the above, an ash-leaching operation was selected for the PRA.

Past documentation of criticality safety evaluations were provided to the risk analysts along with operating procedures. Review of these documents led to the need to perform additional criticality analyses to better define the critical point for various upset conditions. (The original criticality safety evaluations generally documented that certain upset sequences would be subcritical, but usually did not calculate the exact conditions required to reach criticality.) For most situations, this can require significant, additional analyses (cost and staff time), and results in no increase in criticality safety.

During this data-gathering phase, the PRA experts held many discussions with both operations personnel and criticality safety staff, reviewed procedures, and observed operations. This was perceived by them as particularly necessary because operations are influenced heavily by human actions and very little by hardware. Also during this time, the criticality staff attempted to educate themselves on PRA methodologies, nomenclature, limitations, expectations of results, and so on. One particularly illuminating document on the general issue of quantitative risk assessment is noted.<sup>4</sup>

## RESULTS

Two distinct applications were evaluated by outside PRA specialists working closely with Los Alamos operations and criticality safety staff. The first occurred in the 1988-1989 time frame and was associated with updating the SAR for the Los Alamos Plutonium Facility.

### Plutonium Facility

For the ash-leaching operation, the general scenario that potentially could lead to the critical event was evaluated to be:

1. Fissile material inventory substantially exceeds the allowed mass in solution for the glovebox;
2. A chemical explosion or some other mechanism leads to the instantaneous rupture of adjacent vessels containing rich solution;
3. The solution collects in one of the deep, compact wells that extend downward from the floor of a few gloveboxes; and,
4. Influx of additional solution into the deep, compact well occurs.

Information gathering included: extensive observations of actual operations, discussions with both process operators and supervisors, review of operating procedures and safety manuals, discussions with criticality safety staff, and additional criticality analyses performed by Los Alamos staff. Fault trees were

then generated and evaluated, with human errors and their likelihoods being the major contributors in all cases. While the result indicated an accident frequency of slightly less than one in a million per year, it was acknowledged that additional conservatisms were not modeled in the PRA. This was partially due not only to the difficulty in assigning likelihoods to those factors, but also to the upfront goals: To understand how PRA might be applied in typical hands-on operations and to appreciate the major contributors to accident sequences.

For the plutonium facility fault tree, the major cutset (which contributed about 35% of the total likelihood) is presented in Table 1. It was interesting to note that in spite of conservatisms not modeled, the frequency was evaluated to be below a common threshold for credible, namely  $1.0 \times 10^{-6}$  per year. Also interesting was the result that no weak links or process upsets that had not been considered in the original review and analysis for this operation were revealed.

**TABLE 1**

**MAJOR CONTRIBUTING CUTSET**

|       |    |                               |
|-------|----|-------------------------------|
| 0.6   | -- | On Shift                      |
| 0.1   | -- | Reactive Material             |
| 0.03  | -- | Too Rapid Addition            |
| 0.9   | -- | Explosion/Breach              |
| 0.5   | -- | All Glass Tanks               |
| 0.25  | -- | Full Pu Inventory             |
| 0.05  | -- | Previous Dissolver Overflow   |
| 0.3   | -- | On Shift                      |
| 0.05  | -- | Sufficient Pu in Overflows    |
| 0.05  | -- | Pu in Well Undetected         |
| 0.01  | -- | Water Added                   |
| <hr/> |    |                               |
| TOTAL | =  | $7.5 \times 10^{11}$ per Hour |
|       | =  | $2 \times 10^7$ per Year      |

(Based on a 50-hour work week)

The output of this fault tree is a likelihood that must be combined with a consequence to arrive at a risk. For hands-on operations such as in the plutonium facility, a likely result of a criticality accident would be one or at most a few worker fatalities and insignificant off-site exposures or contamination. Thus, accepting the "consequence" to be a "criticality accident" and not attempting to

differentiate between accidents with and without radiation exposures or degrees of exposures, one can equate the fault-tree output to a measure of risk.

### **Nuclear Materials Storage Facility**

The second application occurred in the 1990-1991 time frame and involved a new nuclear materials storage facility that is still not 100% completed. Due to the planned absence of solution storage and the planned use of overpacks to preclude high-density accumulations under upset conditions, it was very difficult to arrive at credible accident sequences. While not yet complete due to the incomplete status of facility construction and documentation, indications are that the total facility likelihood of a criticality accident should be less than one in a million per year.

### **CONCLUSIONS**

PRA-expert contractors, assisted by Los Alamos operations and criticality safety personnel performed quantified risk assessments on operations in two Los Alamos facilities. These evaluations were thorough in identifying potential paths leading to a critical condition. The fault-tree analyses confirmed the professional judgement of Los Alamos operations and criticality safety staff (as documented in formal procedures); namely, operations and their criticality-related controls provided acceptably low criticality risks. Both PRAs indicated accident frequencies should be less than one in a million per year.

Based on these two "experiments," i.e., PRAs, the following observations and concerns (related to hands-on operations typical of the R&D operations at Los Alamos) are offered:

- Widespread application of quantified risk assessments could result in a focus on risk assessment rather than risk reduction. Experienced PRA assessors and criticality safety staff are both scarce; diverting the former from analyses involving higher consequences or diverting the latter from established risk-control methods should be carefully considered.
- Small likelihood values have a tendency to lull one into a false sense of security, which could reduce the important task of continuing awareness and familiarity with process operations by criticality safety staff. Relatedly, if regulatory likelihoods are prescribed, then people will find a way to generate numbers to meet established criteria. There will never be a substitute for on-site operational reviews by knowledgeable personnel.
- Regardless of the resultant likelihoods derived from fault trees, their completeness will always be judgmental. If used, they must be largely the efforts of experienced on-site staff, both process and criticality.
- Uncertainty bounds appear to be highly dependent on individual PRA evaluators for operations driven largely by human interactions, and substantiation of these bounds may be difficult.

- These two PRAs had costs, exclusive of Los Alamos staff time, of about \$20,000 each. While economies of scale could lead to reductions in additional, related applications, the demands on staff time would be unacceptable. Additionally, such PRAs will either need continual updating as processes change or become entirely obsolete within a few years, particularly in R&D climates.

In summary, the experience to date at Los Alamos demonstrates that the application of quantified risk assessment techniques has not had cost/benefit features conducive to future applications. Conventional risk control measures have been demonstrated to be effective over the past two-plus decades.

## REFERENCES

1. R. R. Jackson, and W. A. Melody, "Final Report, Nuclear Criticality Accident Analysis, (TA-55, PF-4)," SAIC-89/1590 (1989).
2. T. P. McLaughlin, "Process Criticality Accident Likelihoods, Consequences and Emergency Planning," *Nuclear Energy*, Vol. 31, No. 2, pp. 143-147.
3. D. R. Smith, "A Review of Criticality Accidents," Nuclear Criticality Information System report DOE/NCT-04 (1989).
4. J. S. Arendt, D. K. Lorenzo, and A. F. Lusby, "Evaluating Process Safety in the Chemical Industry — A Manager's Guide to Quantitative Risk Assessment," JBF Associates, Inc. report (1989).



# GLOSSARY OF NUCLEAR CRITICALITY TERMS\*

Hugh C. Paxton

## ABSTRACT

This is a glossary of terms generally encountered in the literature of nuclear criticality and criticality safety. Terms sometimes misused are emphasized.

The potential value of a glossary of terms related to nuclear criticality is suggested by the observation that less than one-half of such terms in a 1989 manuscript on criticality accidents (D. R. Smith, "A Review of Criticality Accidents," DOE/NCT-04, 1989) are adequately defined in the 1986 *Glossary of Terms in Nuclear Science and Technology*. The present compilation may be considered a supplement to that document to encourage the consistent use of nuclear criticality terms.

The following pair of terms are so basic and so intertwined that they call for special consideration inconsistent with the body of this glossary. Consequently, they are given this introductory position.

**critical, criticality:** Proper use is generally consistent with the following definition from Webster's New International Dictionary, Second Edition, Unabridged:

-ity. A suffix denoting state, condition, quality, or degree, used to form abstract nouns from adjectives, as in acidity, calamity.

Thus "delayed criticality" and "delayed critical state" are equivalent. "Critical" is not used as a noun, but may seem so by implying "critical state" in legends of graphs or charts where space is at a premium. Where the meaning of "critical" as an adjective may be misinterpreted, as in "critical terms" or "critical accident," "criticality" may be substituted for clarification. Use of "a criticality" for "a critical condition" or simply for "criticality," as is sometimes heard, is unacceptable. See *delayed criticality, prompt criticality*.

---

\* From Los Alamos National Laboratory report LA-11627-MS, October 1989.

**albedo, neutron:** The probability under specified conditions that a neutron entering into a region through a surface will return through that surface.<sup>1</sup>

**absorbed dose:** The energy imparted to matter by directly or indirectly ionizing radiation per unit mass of irradiated material at the point of interest; the unit of absorbed dose has been the rad and now in the International System of Units (SI) is the gray (Gy), 100 rad = 1 Gy.<sup>2,3</sup> See *rad, gray*.

**absorption, neutron:** A neutron-induced reaction, including fission, in which the neutron disappears as a free particle.<sup>1</sup> The absorption cross section is designated  $\sigma_a$ . See *capture, neutron; cross section, neutron*.

**alarm system, criticality accident:** A system capable of sounding an audible alarm after detecting neutron or gamma radiation from a criticality accident. See *criticality accident*.

**alpha particle:** A helium-4 nucleus emitted during a nuclear transformation.<sup>1</sup>

**beta particle:** An electron of either positive or negative charge that has been emitted during a nuclear transformation.<sup>1</sup>

**buckling:** For our purposes, algebraic expressions that relate critical dimensions of various simple shapes (sphere, cylinder, or cuboid) of cores of the same composition and similar reflectors. For example, the known radius of a critical sphere may be used to obtain the radius and length of a corresponding critical cylinder. For a specific definition of buckling, see Ref. 4, pp 7 and 8. See *core, reflector*.

**burst, prompt:** Usually refers to the pulse of energy from fissions produced by a prompt burst reactor. See *prompt burst reactor, spike (in a prompt power excursion)*.

**capture, neutron:** Neutron absorption not leading to fission or other neutron production. The capture cross section is designated  $\sigma_c$ . See *absorption, neutron; cross section, neutron*.

**cent:** A unit of reactivity equal to one-hundredth of the increment between delayed criticality and prompt criticality (a dollar).<sup>1</sup> See *dollar, reactivity*.

**chain reaction, fission:** A sequence of nuclear fission reactions in which fissions are induced by neutrons emerging from preceding fissions. Depending on whether the number of fissions directly induced by neutrons from one fission is on the average less than, equal to, or greater than unity, the chain reaction is convergent (subcritical), self-sustaining (critical), or divergent (supercritical).<sup>1</sup>

**core:** That part of a fissile system containing most or all of the fissile material, as distinguished from an external reflector. See *fissile system, reflector*.

**critical infinite cylinder:** For specified fissile medium and surrounding reflector, the infinitely long cylinder with a diameter that would be critical.

**critical infinite slab:** For specified fissile medium and reflector on each surface, the slab of infinite lateral dimensions with a thickness that would be critical.

**criticality accident:** The release of energy as a result of accidentally producing a self-sustaining or divergent fission chain reaction.<sup>1</sup> See *chain reaction, fission*.

**criticality safety:** Protection from the consequences of a criticality accident, preferably by prevention of the accident.<sup>4</sup> Encompasses procedures, training, and other precautions in addition to physical protection. See *criticality accident*.

**criticality safety standards:** These standards describe criticality control practices for which there is industry-wide consensus. Consensus is established through procedures of the American National Standards Institute. Chapter 4 of Ref. 4 lists and discusses existing and proposed criticality safety standards, and explains capitalization of the term. See also the section on standards in this manuscript.

**cross section ( $\sigma$ ), neutron:** The proportionality factor that relates the rate of a specified reaction (such as capture or fission) to the product of the number of neutrons per second impinging normally onto a unit area of a thin target and the number of target nuclei per unit area. It may be considered a small area assigned to each target nucleus, usually expressed in barns, i.e.,  $10^{-24}$  cm<sup>2</sup>. See *absorption, neutron; capture, neutron; fission, nuclear*.

**decay, radioactive:** A spontaneous nuclear transformation in which particles or gamma radiation are emitted, in which x-radiation is emitted following orbital electron capture, or in which the nucleus undergoes spontaneous fission.<sup>1</sup> See *fission, nuclear; gamma radiation*.

**delayed criticality:** State of a fissile system such that  $k_{eff} = 1$ , the steady-state condition. See *multiplication factor*.

**delayed neutrons:** Neutrons from nuclei produced by beta decay following fission. They follow fission by intervals of seconds to minutes. See *prompt neutrons*.

**dollar:** A unit of reactivity equal to the increment between delayed criticality and prompt criticality for a fixed chain-reacting system. See *reactivity*.

**dose equivalent:** The absorbed dose multiplied by the quality factor and other less significant modifying factors, so that doses from different radiations (alpha, beta, gamma, slow neutron, fast neutron) can be summed to provide an effective total dose at the point of interest.<sup>2</sup> The conventional unit of dose equivalent has been the rem, and now in the International System of Units (SI) is the sievert (Sv), 100rem = 1 Sv.<sup>5</sup> See *rem, sievert*.

**dose rate:** Absorbed dose delivered per unit time.<sup>2</sup> See *absorbed dose*.

**excursion, nuclear:** An episode during which the fission rate of a supercritical system increases, peaks, and then decreases to a low value.

**excursion, prompt-power:** A nuclear excursion as the result of a prompt-critical configuration of fissile material. In general, a sharp power spike followed by a plateau that may be interrupted by smaller spikes. See *excursion, nuclear; spike (in a prompt power excursion)*.

**excursion period (T):** The reciprocal coefficient of time (t), where fission power in a nuclear excursion increases as  $e^{vT}$  before a quenching mechanism becomes effective. See *excursion, nuclear; quenching mechanism*.

**exponential column:** A subcritical block or cylinder of fissile-bearing material with an independent neutron source at one end. Under appropriate conditions, the response of a neutron detector decreases exponentially with distance from the source. From the logarithmic rate of this decrease and lateral dimensions of the column, critical dimensions of an unreflected assembly of the material may be deduced.

**exposure:** A measure of the ionization produced in air by x-rays or gamma radiation; the sum of electric charges on all ions of one sign in a small volume of air when all electrons liberated by photons are completely stopped, per unit mass of the air. Note that exposure refers to the environment, not absorbing material. The unit of exposure is the roentgen.<sup>2</sup> See *gamma radiation, roentgen*. Alternatively, exposure is the incidence of radiation on living or inanimate material.<sup>1</sup>

**favorable geometry:** Geometric constraint of fissile material in which subcriticality is maintained under anticipated conditions. Examples are limited diameter of pipes intended to contain fissile solution or limited volumes of solution containers.

**fissile nucleus:** A nucleus capable of fission by thermal neutrons, provided the effective neutron production cross section,  $v\sigma_f$ , exceeds the effective absorption cross section,  $\sigma_a$ . The common fissile nuclei are  $^{235}\text{U}$ ,  $^{239}\text{Pu}$ , and  $^{233}\text{U}$ .<sup>1</sup> See *absorption, neutron; fission, nuclear*.

**fissile system:** A system containing  $^{235}\text{U}$ ,  $^{239}\text{Pu}$ , or  $^{233}\text{U}$  nuclei and capable of significant neutron multiplication. See *fissile nuclear; multiplication, subcritical*.

**fission, nuclear:** Disintegration of a nucleus (usually, Th, U, Pu, or heavier) into two (rarely more) masses of similar order of magnitude, accompanied by a large release of energy and the emission of neutrons.<sup>1</sup> Although some fissions take place spontaneously, neutron-induced fissions are of major interest in criticality safety. The fission cross section is designated  $\sigma_f$  and  $\nu$  is the number of neutrons emitted per fission. See *cross section, neutron*.

**fission products:** Nuclides produced by fission or by the subsequent radioactive decay of nuclides formed in this manner.<sup>1</sup> See *fission, nuclear; nuclide*.

**fission yield, excursion:** The total number of fissions in a nuclear excursion. See *excursion, nuclear*.

**fissionable nucleus:** A nucleus capable of fission by neutrons of some energy. Fissionable nuclei include  $^{235}\text{U}$ ,  $^{240}\text{Pu}$ , and others with neutron-energy fission thresholds, in addition to those that are fissile. See *fissile nucleus*.

**gamma radiation:** Short wave-length electromagnetic radiation emitted in the process of nuclear transition or particle annihilation.<sup>1</sup>

**gray (Gy):** A unit of absorbed dose; 1 Gy = 1 Joule/kilogram (J/kg) = 100 rads. Adopted in 1976 by the International Conference on Weights and Measures to replace the rad.<sup>5</sup> See *rad*.

**hazard:** A potential danger. "Potentially hazardous" is redundant. Note that a hazardous facility is not necessarily a high-risk facility. See *risk*.

**H/X:** Conventionally, the atomic ratio of hydrogen to  $^{235}\text{U}$ ,  $^{239}\text{Pu}$ , or  $^{233}\text{U}$  in a solution or hydrogenous mixture. Where there is more than one fissile species, the ratios must be specified separately.

**inhour:** A unit of reactivity that when added to the delayed-critical system would produce a period of one hour; now seldom used.<sup>1</sup> See *reactivity*.

**ionizing radiation:** Any radiation consisting of directly or indirectly ionizing particles, photons, or a mixture of both. X-rays and the radiations emitted in radioactive decay are examples.<sup>1</sup> See *decay*, *radioactive*.

**irradiation:** Exposure to ionizing radiation.<sup>1</sup> See *exposure* (alternative definition).

**isotopic code:** Combined final digits of atomic number and atomic weight, such that  $^{235}\text{U}$ ,  $^{239}\text{Pu}$ , and  $^{233}\text{U}$  are represented '25', '49', and '23';  $^{240}\text{Pu}$ , however, is called '410'; these appear in some documents but now are seldom used.

**linear energy transfer (LET):** The average energy lost by an ionizing radiation per unit distance of its travel in a medium. A high LET is generally associated with protons, alpha particles, and neutrons, whereas a low LET is associated with x-rays, electrons, and gamma rays.<sup>2</sup> See *ionizing radiation*.

**monitor, radiation:** A detector to measure the level of ionizing radiation. A purpose may be to give information about dose or dose rate.<sup>1</sup> See *ionizing radiation*.

**multiplication, subcritical:** In a subcritical system containing a neutron source, the equilibrium ratio of the total number of neutrons resulting from fission and the source to the total number of neutrons from the source alone.<sup>1</sup>

**multiplication factor ( $k_{eff}$ ):** For a chain-reacting system, the mean number of fission neutrons produced by a neutron during its life within the system. It follows that  $k_{eff} = 1$ , if the system is critical;  $k_{eff} < 1$ , if the system is subcritical;  $k_{eff} > 1$ , if the system is supercritical.

**neutron:** An elementary particle having no electrical charge, a rest mass of  $1.67495 \times 10^{-24}$  g, and a mean life of about ten minutes.<sup>1</sup>

**neutron poison:** A nonfissionable neutron absorber, generally used for criticality control. See *absorption, neutron; capture, neutron*.

**neutrons, epithermal:** Neutrons of kinetic energy greater than that of thermal agitation, often restricted to energies comparable with those of chemical bonds.<sup>1</sup>

**neutrons, fast:** Neutrons of kinetic energy greater than some specified value, often chosen to be 0.1 MeV.<sup>1</sup>

**neutrons, thermal:** Neutrons in thermal equilibrium with the medium in which they exist.<sup>1</sup> At room temperature, the mean energy of thermal neutrons is about 0.025 eV.

**nonfavorable geometry:** See *favorable geometry*.

**nuclide:** A species of atom characterized by its mass number, atomic number, and a possible elevated nuclear energy state if prolonged.<sup>1</sup>

**oralloy (Oy):** Introduced in early Los Alamos documents to mean enriched uranium (Oak Ridge alloy); now uncommon except to signify highly enriched uranium. See *tuballoy*.

**personnel monitor (radiation):** A device for measuring a person's exposure to radiation. Information on the dose equivalent of ionizing radiation to biological tissue is derived from exposures recorded by film badges, ionization chambers, and thermoluminescent devices; from whole-body counting and analysis of biological specimens; and from area monitoring and special surveys.<sup>2</sup>

**photon:** A quantum of electromagnetic radiation.<sup>1</sup>

**prompt burst reactor:** A device for producing nondestructive superprompt-critical nuclear excursions. See *burst, prompt; excursion, nuclear*.

**prompt criticality:** State of a fissile system such that the prompt-neutron contribution to  $k_{eff}$  equals unity. See *multiplication factor*.

**prompt neutrons:** Neutrons emitted immediately during the fission process. See *delayed neutrons*.

**quality factor (QF):** The linear energy-transfer-dependent factor by which absorbed doses are multiplied to obtain, for radiation protection purposes, a quantity that expresses on a common scale the biological effectiveness of the absorbed dose derived from various radiation sources.<sup>2</sup> Approximately the ratio of dose equivalent and absorbed dose. See *absorbed dose, dose equivalent, linear transfer energy*.

**quenching mechanism:** Physical process other than mechanical damage which limits an excursion spike. Examples are thermal expansion or microbubble formation in a solution. See *spike (in prompt power excursion)*.

**rad:** A unit of absorbed dose;  $1 \text{ rad} = 10^{-2} \text{ J/kg}$  of the medium. In 1976, the International Conference on Weights and Measures adopted the gray as the preferred unit of absorbed dose,<sup>6</sup> but this unit has not appeared in the criticality accident literature, which was essentially complete before that date. See *absorbed dose, gray*, and discussion under *personnel monitor*.

**radiation:** In context of criticality safety, alpha particles, beta particles, neutrons, gamma rays, and combinations thereof. See *alpha particle, beta particle, radiation, neutron, x-ray*.

**reactivity:** A parameter of a fissile system which is proportional to  $1 - 1/k_{\text{eff}}$ . Thus, it is zero if the system is critical, positive if supercritical, and negative if subcritical. See *dollar, cent, inhour*, various units of reactivity, *multiplication factor*.

**reflector:** Material outside the core of a fissile system capable of scattering back to the core some neutrons that would otherwise escape. See *core, fissile system*.

**reflector savings:** The absolute difference between a dimension of the reflected core of a critical system and the corresponding dimension of a similar core that would be critical if no reflector were present.<sup>1</sup> See *core, fissile system, reflector*.

**relative biological effectiveness (RERf):** A factor used to compare the biological effectiveness of absorbed radiation doses (i.e., rads or grays) because of different types of ionizing radiation; more specifically, it is the experimentally determined ratio of an absorbed dose of radiation in question compared with the absorbed dose of a reference radiation required to produce an identical biological effect in a particular experimental organism or tissue.<sup>3</sup> This term should be used only in radiobiology. See *quality factor*.

**rem:** A unit of dose equivalent (roentgen equivalent man), replaced by the sievert, which was adopted in 1980 by the International Conference on Weights and Measures.<sup>5</sup> This unit, however, has not appeared in criticality accident literature. See *dose equivalent, sievert*.

**rep:** An obsolete term for absorbed dose in human tissue. It was replaced by rad. Originally derived from roentgen equivalent physical.<sup>1</sup>

**roentgen (R):** A unit of exposure;  $1 \text{ R} = 2.58 \times 10^{-4} \text{ C/kg}$  in air, where C is coulombs.<sup>3</sup> Strictly, the roentgen applies to x-rays or gamma radiation, although in one report of a criticality accident, beta "dosages" are expressed in units of R. See *exposure*.

**scram:** An alternative term for reactor trip.<sup>1</sup> Reference 6 gives accounts of the origin of this term.

**shutdown mechanism:** Quenching mechanism and mechanical damage, if any, that limits a prompt-power excursion spike. See *excursion, prompt power; quenching mechanism, spike*.

**sievert (Sv):** A unit of dose equivalent;  $1 \text{ Sv} = 1 \text{ J/kg} = 100 \text{ rem}$ . Adopted in 1980 by the International Conference on Weights and Measures to replace the rem.<sup>5</sup> See *dose equivalent, rem*.

**spike (in a prompt-power excursion):** The initial power pulse of a prompt-power excursion, limited by the shutdown mechanism. See *excursion, prompt-power; shutdown mechanism*.

**tuballoy:** A wartime term for *natural uranium*, originating in England, now obsolete. See *oralloy*.

**uranium enrichment (enrichment):** The weight percentage of  $^{235}\text{U}$  in uranium, provided that that percentage exceeds its natural value; if the reference is to enhanced  $^{233}\text{U}$  content, " $^{233}\text{U}$  enrichment" should be specified.

**x-ray:** Electromagnetic radiation of wavelength in the range  $10^{-10} \text{ cm}$  to  $10^{-8} \text{ cm}$ .<sup>7</sup>

#### REFERENCES

1. *Glossary of Terms in Nuclear Science and Technology*, 1986 revision, prepared by ANS-9, the American Nuclear Society Standards Subcommittee on Nuclear Terminology and Units, Harry Alter, chairman, American Nuclear Society Publication, LaGrange, Illinois.
2. "Terms Used in Radiation, Radiobiology, and Radioepidemiology," George L. Voelz, M.D., compiler, Group HSE-2, Los Alamos National Laboratory.
3. *Radiological Health Handbook*, Glossary, pp 413-441, Revised Edition, January 1970, U.S. Department of Health, Education, and Welfare, Public Health Service, Consumer Protection and Environmental Health Service, Rockville, Maryland 20852.
4. *Nuclear Criticality Safety Theory and Practice*, Ronald A. Knief, American Nuclear Society, LaGrange Park, Illinois (1985).
5. *Dictionary of Scientific Units*, H. G. Jerrard, and D. B. McNeill, Fifth Edition, Chapman and Hall, London (1972).
6. Raymond L. Murray, "The Etymology of 'Scram'", *Nuclear News*, August 1988, pp. 105-107; "Letters" *Nuclear News*, December 1988, pp. 17,18.
7. *University Physics*, 2nd Edition, F. W. Sears and M. W. Zemansky, Addison-Wesley, Reading, Massachusetts (1955).



# NUCLEAR CRITICALITY SAFETY COURSE

## REFERENCE LIST

International Directory of Nuclear Criticality Safety Personnel

Oden, D. R., J. K. Thompson, M. A. Lewellan, and T. J. Trapp, "Critique of Solid Angle Method," NUREG/CR-0005, February 1978.

Paxton, H. C., "Capsule Storage and Density-Analog Techniques," LA-5930-MS, May 1975.

Paxton, H. C., "Criticality Control in Operations with Fissile Material," LA-3366(Rev), November 1972.

Paxton, H. C., "Glossary of Nuclear Criticality Terms," LA-11627-MS, October 1989.

Paxton, H. C. and N. L. Pruvost, "Critical Dimensions of Systems Containing  $^{235}\text{U}$ ,  $^{239}\text{Pu}$ , and  $^{233}\text{U}$ ," (formerly TID-7028), LA-10860-MS, July 1987.

Pruvost, N. L. and M. L. Prueitt, "The Hansen-Roach Cross Sections—A Graphical Representation," LALP-88-20, October 1988.

Stratton, W. R., "A Review of Criticality Accidents," LA-3611, September 1967 (revised by D. R. Smith, DOE/NCT-04, March 1989).

Stratton, W. R., "Criticality Data and Factors Affecting Criticality of Single Homogeneous Units," LA-3612, September 1967.

Thomas, J. T., "An Evaluation of the Solid Angle Method Used in Nuclear Criticality Safety," NUREG/CR-2333, ORNL/CSD/TM-158, June 1982.

Thomas, J. T., "Comparative Method of the Evaluation of Array Reflector Materials," ORNL/CSD-42C, October 1979.

Thomas, J. T., "Nuclear Safety Guide TID-7016," Rev. 2, NUREG/CR-9995, ORNL/NUREG/CSD-6, June 1978.

Thomas, J. T., "Solid Angle and Surface Density as Criticality Parameters," NUREG/CR-1615, ORNL/NUREG/CSD/TM-15, October 1980.

Thomas, J. T., "The Effect of Reflector Location on Array Criticality," NUREG/CR-1616, NUREG/CR-1616, November 1980.

Thompson, J. K., M. A. Lewellan, and T. J. Trapp, "Snake: A Solid Angle Computational System," NUREG/CR-0004, February 1978.